

News 2019

Hardware

HEWI

Matt edition
Cabinet hardware
Range 270
Panic bar glow
Kids



HEWI Hotline

Monday – Thursday between 7 am and 5 pm
Friday between 7 am and 3 pm
Tel.: +49 5691 82-0
Fax: +49 5691 82-319
eMail: international@hewi.com

Matt edition	2
<hr/>	
Introduction	2 – 3
mini	4 – 11
bicolor	12 – 19
System 111	
R-Technology	20 – 23
Components R-Technology	24
Push & pull handle	25
Window handles	26
Pull handles	27 – 29
Fixing types pull handles	30 – 31
Hooks	32 – 35
Coat hanger	35
Cabinet hardware	
Furniture handles	36 – 43
Cupboard knobs	44 – 46
Fixing types	47
Flush pulls	48 – 49
Door accessories	
Symbols	50
Door stops	51
Hinges	52 – 54
Cabinet Hardware	56
<hr/>	
Furniture handles	57
Cupboard knobs	58 – 59
Flush pulls	59
Range 270	60
<hr/>	
Model 270XAM	61
Panic bar glow	62
<hr/>	
Panic bar glow – luminescent	63 – 64
Accessories	65
Kids	66
<hr/>	
Benches	68
Cloakroom-modules	68 – 71

Matt edition

Exclusive surface

SERVICES

Online catalogue

The HEWI online catalogue simplifies product searches. You are quickly routed to the required product areas via article numbers or keywords. All important information on the surface, cleaning and technology is summarised here and is available to download.

www.hewi.com/en/catalogue-edition-matt

Configurator

Give free rein to your creativity and configure your own personal design object. With the help of the configurator, you can put together your own individual door lever handle – be it as a one-off or as a continuous design object.

www.hewi.com/en/configurator



For HEWI, the choice of surface is an independent dimension of product design. HEWI provides a unique surface with the matt edition, which appeals to the senses and at the same time creates space for individuality. Away from high-gloss towards soft look surfaces: matt is becoming the symbol of exclusiveness. Utilising the matt edition enables you to add sensuous accents, which have a convincing characteristic look and a very special feel. You can emphasise your style or, in combination with high-gloss surfaces – create interesting counterparts. The comprehensive product range, comprises the door lever handle series 250 models, system 162 and 111 in the bicolour and mini variants, furniture hardware, hooks and coat hangers and enables a wide variety of design freedom.



CONFIGURATOR

Individuality is configurable:
Design your own personal door
lever handle combination at:
www.hewi.com/en/configurator



Model 111.23PBM

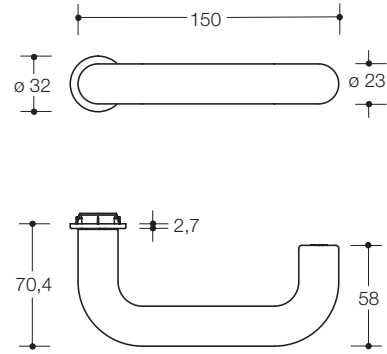

Lever handle 111.23PBM with mini roses, matt polyamide
Polyamide, matt available HEWI colours see below
 EN 1906 class 4

Fig.: Lever handle and rose in 92 (anthracite grey)

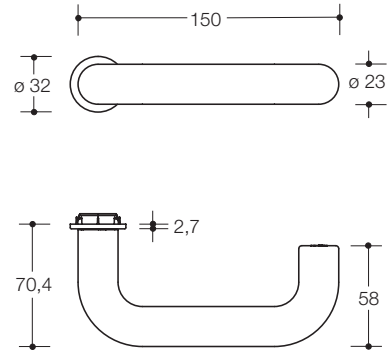

Lever handle 111.23PBM with mini roses, stainless steel and PVD
Polyamide, matt available HEWI colours see below
 EN 1906 class 4

Fig.: Lever handle in 92 (anthracite grey)
 with rose in matt copper

MATERIAL | COLOUR
LEVER HANDLE, ROSES

- Polyamide, matt**
- 99
 - 92
 - 90

MATERIAL | SURFACE
ROSES

Stainless steel

- XA matt
- XC polished

PVD (Stainless steel)

- Brass** matt polished
- Copper** matt polished
- Black chrome** matt polished

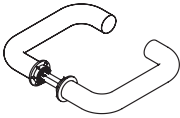
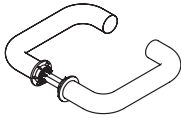
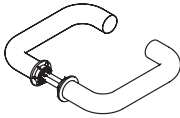
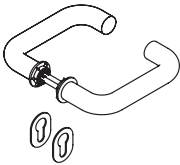
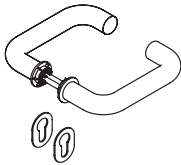
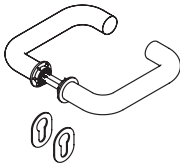
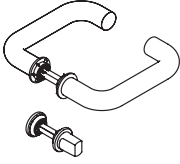
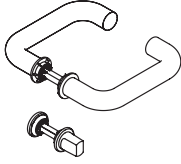
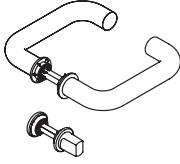
Model 111.23PBM	mini roses polyamide, matt	mini roses stainless steel matt or polished	mini roses PVD (stainless steel) matt or polished (brass, copper, black chrome)
Standard door fitting without escutcheon			
class 4	111PBM06.230	111PBMX06230	111PBMV06230
Standard door fitting			
class 4	111PBM01.230	111PBMX01230	111PBMV01230
Vacant/engaged fitting			
class 4	111PBM02.230	111PBMX02230	111PBMV02230

Escutcheon (self-adhesive)
for standard door fittings
306PBM Polyamide, matt
306XAM Stainless steel
306XCM Stainless steel
306VM PVD (Stainl. steel)

Rose with turn knob | M, FBM (coin)
for vacant/engaged fittings
306PBMNR Polyamide, matt
306PBXAMNR Stainl. steel*
306PBXCMNR Stainl. steel*
306PBVMNR PVD (St. steel)*



*Latch made of matt polyamide

ORDERING INFORMATION

CROSS-REFERENCES

mini is available with square 8 mm and 8.5 mm for door thickness ranges from 38.1 to 78 mm.

Individually configured matt edition fittings are non-returnable.

Item Number
Colour lever handle
Colour/surface rose
Square
Door thickness
Keyway

HEWI Spindles, installation jigs
see Catalogue Hardware 2018/19 page 199

Model 162.21PBM

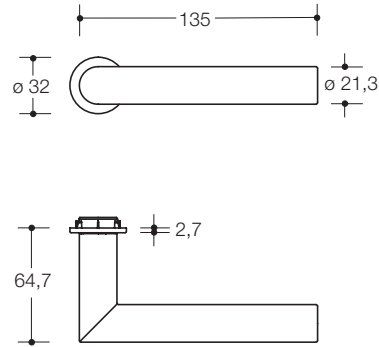

Lever handle 162.21PBM with mini roses, matt polyamide
Polyamide, matt available HEWI colours see below
 EN 1906 class 4

Fig.: Lever handle and rose in 92 (anthracite grey)

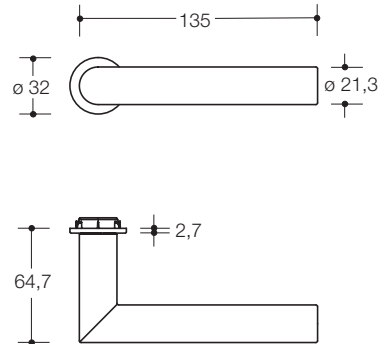

Lever handle 162.21PBM with mini roses, stainless steel and PVD
Polyamide, matt available HEWI colours see below
 EN 1906 class 4

Fig.: Lever handle in 92 (anthracite grey)
 with rose in matt copper

MATERIAL | COLOUR
LEVER HANDLE, ROSES

- Polyamide, matt**
- 99
 - 92
 - 90

MATERIAL | SURFACE
ROSES

Stainless steel

- XA matt
- XC polished

PVD (Stainless steel)

- Brass** matt polished
- Copper** matt polished
- Black chrome** matt polished

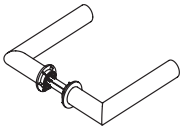
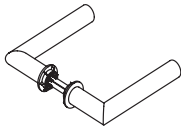
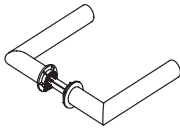
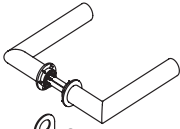
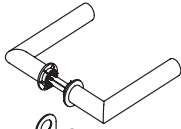
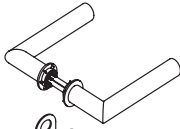
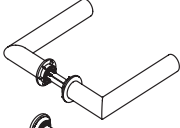
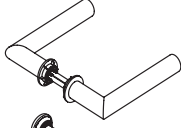
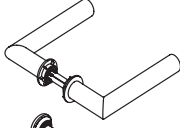
Model 162.21PBM	mini roses polyamide, matt	mini roses stainless steel matt or polished	mini roses PVD (stainless steel) matt or polished (brass, copper, black chrome)
Standard door fitting without escutcheon			
class 4	162PBM06.230	162PBMX06230	162PBMV06230
Standard door fitting			
class 4	162PBM01.230	162PBMX01230	162PBMV01230
Vacant/engaged fitting			
class 4	162PBM02.230	162PBMX02230	162PBMV02230

Escutcheon (self-adhesive)
for standard door fittings
306PBM Polyamide, matt
306XAM Stainless steel
306XCM Stainless steel
306VM PVD (Stainl. steel)

Rose with turn knob | M, FBM (coin)
for vacant/engaged fittings
306PBMNR Polyamide, matt
306PBXAMNR Stainl. steel*
306PBXCMNR Stainl. steel*
306PBVMNR PVD (St. steel)*



*Latch made of matt polyamide

ORDERING INFORMATION

CROSS-REFERENCES

mini is available with square 8 mm and 8.5 mm for door thickness ranges from 38.1 to 78 mm.

Individually configured matt edition fittings are non-returnable.

Item Number
Colour lever handle
Colour/surface rose
Square
Door thickness
Keyway

HEWI Spindles, installation jigs
see Catalogue Hardware 2018/19 page 199

Model 251.21PBM

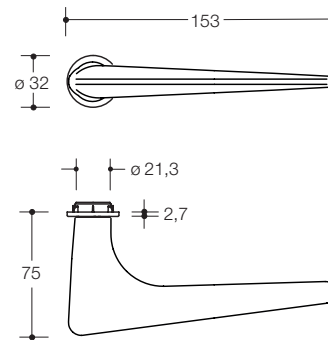

Lever handle 251.21PBM with mini roses, matt polyamide
Polyamide, matt available HEWI colours see below
 EN 1906 class 3

Fig.: Lever handle and rose in 92 (anthracite grey)

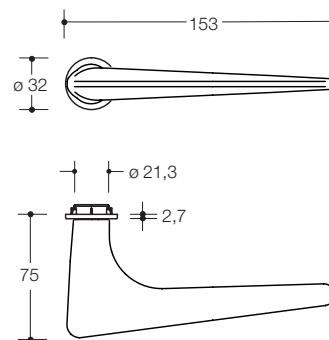

Lever handle 251.21PBM with mini roses, stainless steel and PVD
Polyamide, matt available HEWI colours see below
 EN 1906 class 3

Fig.: Lever handle in 92 (anthracite grey)
 with rose in matt copper

MATERIAL | COLOUR
LEVER HANDLE, ROSES

Polyamide, matt
 99 92 90

MATERIAL | SURFACE
ROSES

Stainless steel

XA matt XC polished

PVD (Stainless steel)

Brass **Copper** **Black chrome**
 matt polished matt polished matt polished

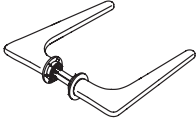
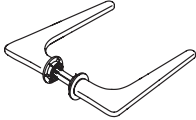
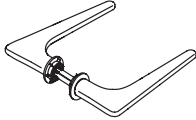
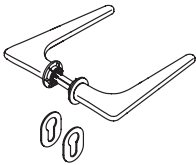
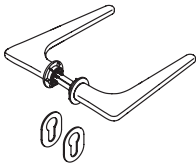
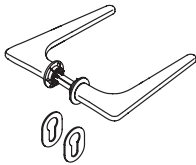
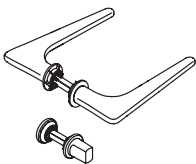
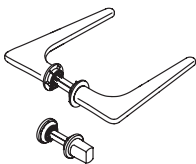
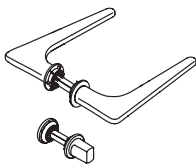
Model 251.21PBM	mini roses polyamide, matt	mini roses stainless steel matt or polished	mini roses PVD (stainless steel) matt or polished (brass, copper, black chrome)
Standard door fitting without escutcheon			
class 3	250PBM06.130	250PBMX06130	250PBMV06130
Standard door fitting			
class 3	250PBM01.130	250PBMX01130	250PBMV01130
Vacant/engaged fitting			
class 3	250PBM02.130	250PBMX02130	250PBMV02130

Escutcheon (self-adhesive)
for standard door fittings
306PBM Polyamide, matt
306XAM Stainless steel
306XCM Stainless steel
306VM PVD (Stainl. steel)

Rose with turn knob | M, FBM (coin)
for vacant/engaged fittings
306PBMNR Polyamide, matt
306PBXAMNR Stainl. steel*
306PBXCMNR Stainl. steel*
306PBVMNR PVD (St. steel)*



*Latch made of matt polyamide

ORDERING INFORMATION

CROSS-REFERENCES

mini is available with square 8 mm and 8.5 mm for door thickness ranges from 38.1 to 78 mm.

Individually configured matt edition fittings are non-returnable.

Item Number
Colour lever handle
Colour/surface rose
Square
Door thickness
Keyway

HEWI Spindles, installation jigs
see Catalogue Hardware 2018/19 page 199

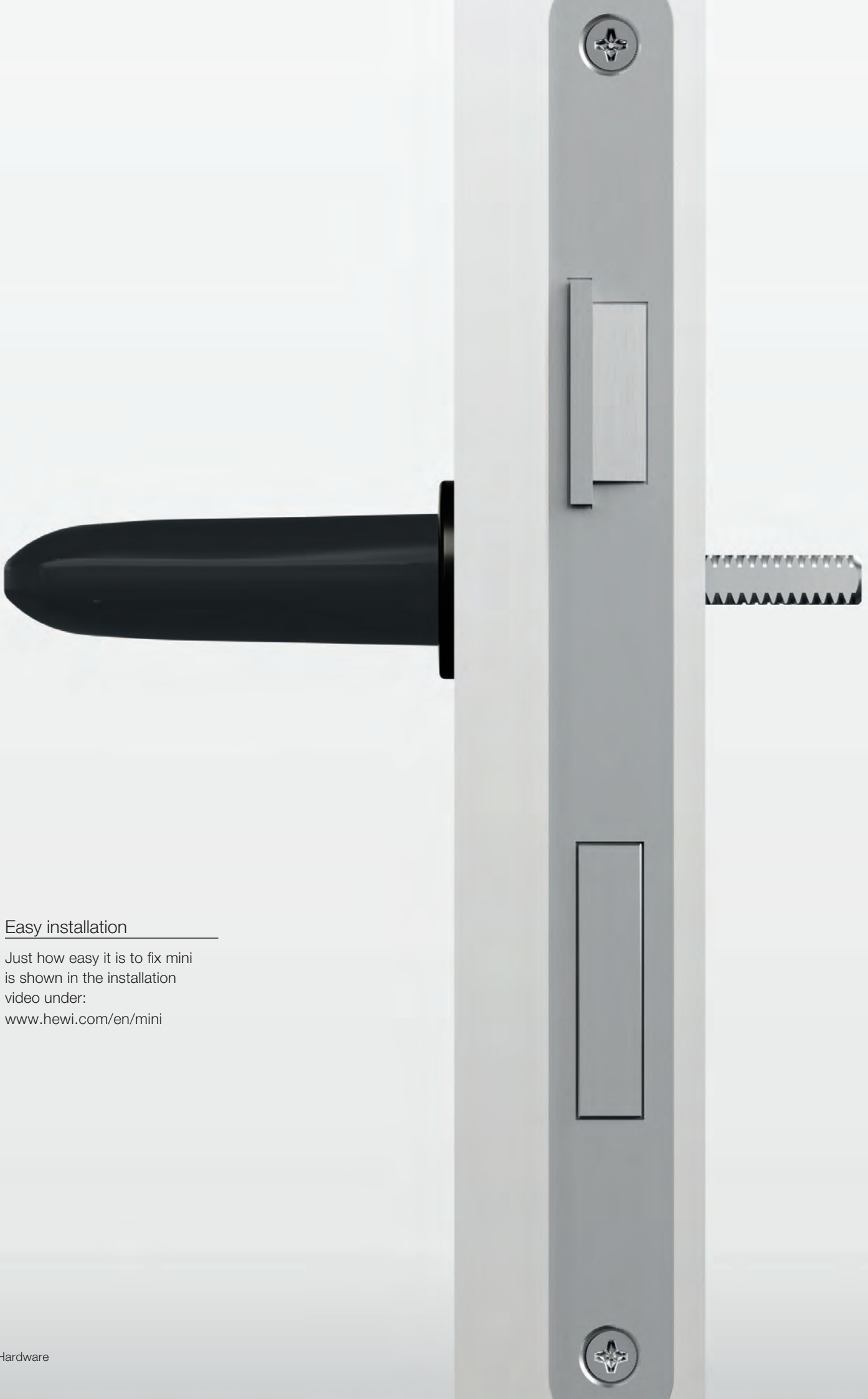

Easy installation

Just how easy it is to fix mini
is shown in the installation
video under:
www.hewi.com/en/mini

Innovative installation concept mini

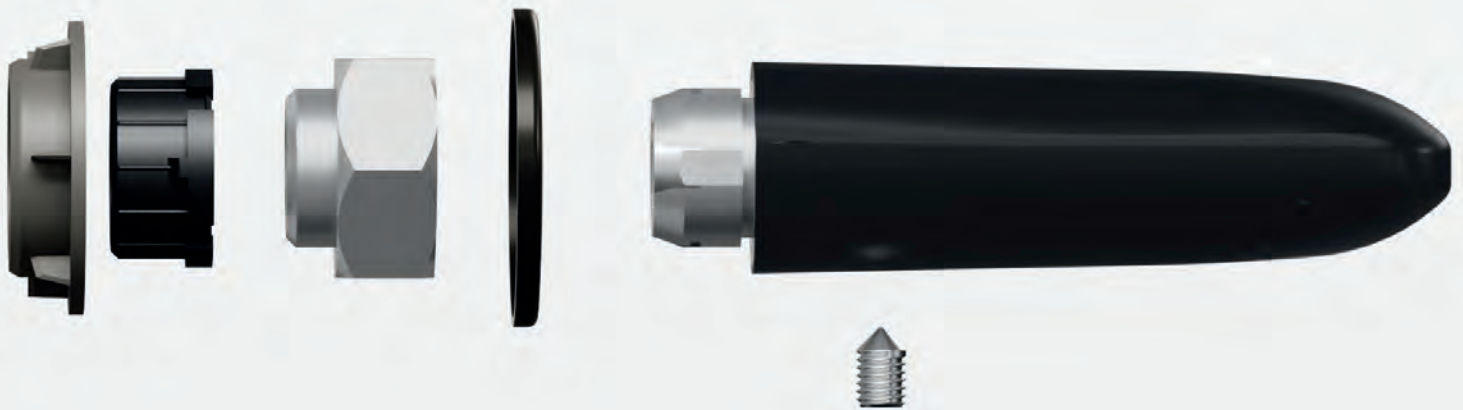

The new mini installation concept allows the door lever handle to be installed without drilling. The drillhole in the door leaf (cut size 25 mm) is sufficient to fix the lever handle. For the installation, one half of the lever handle set with preassembled square spindle and press-in bearing is pushed through the lock follower and with the press-in bearing permanently connected to the other side with the help of a mounting nut and a ring spanner supplied by HEWI. The press-in bearings interlock concentrically

relative to the lock follower, permanently attached to the door panel. Finally, the second lever handle is pushed on and fixed in place using a grub screw. Category of use 4 for moderate to high-frequency use has been confirmed for mini by an independent test institute. Thus mini meets the requirements of the EN 1906 and is suitable for both interior doors in the private sector as well as for office and commercial buildings.

Model 111.23PB

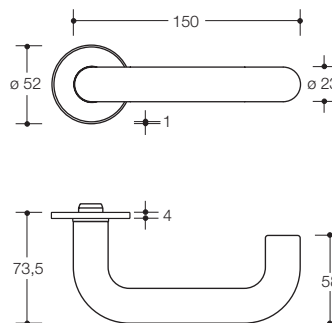

Lever handle 111.23PB

with bicolor roses

Polyamide, matt

available HEWI colours see below

EN 1906 class 4

DIN 18273 **F**

Fig.: Lever handle and inlay in 92 (anthracite grey) with rose in matt copper

	Stainless steel	Brass	PVD (Stainless steel) Copper	Black chrome
matt				
polished				

MATERIAL | COLOUR
LEVER HANDLE, INLAY ROSE

Polyamide, matt

99 92 90

MATERIAL | SURFACE
ROSES

Stainless steel

XA matt XC polished

PVD (Stainless steel)

Brass **Copper** **Black chrome**
 matt polished matt polished matt polished

CONFIGURATOR

Let your creativity run wild: With the help of the configurator, lever handles can be composed according to your personal preferences. Various lever handle models and materials allow countless combinations for individual unique specimen or continuous design objects, which underline the character of the building.

www.hewi.com/en/configurator

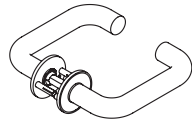
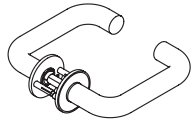
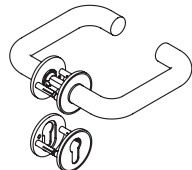
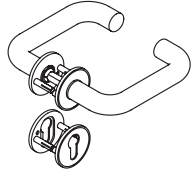
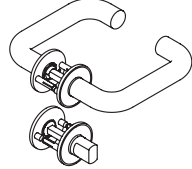
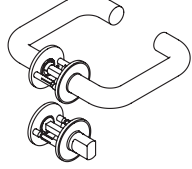
Model 111.23PB	Roses stainless steel matt or polished	Roses PVD (stainless steel) matt or polished (brass, copper, black chrome)
Standard door fitting without escutcheon class 4	 111PBIX06230	 111PBIV06230
Standard door fitting/ Fire door fitting class 4 class 4 F	 111PBIX01230 111PBIX11230	 111PBIV01230 111PBIV11230
Vacant/engaged fitting class 4	 111PBIX02230	 111PBIV02230

Escutcheon
for standard door fittings
306.23PBXI Stainless steel
306.23PBVI PVD (St. steel)

Rose with turn knob | M, FBM* (coin)
for vacant/engaged fittings
306.23PBXINR Stainless steel
306.23PBVINR PVD (St. steel)



*Latch and free/occupied indicator made of
matt polyamide

ORDERING INFORMATION

CROSS-REFERENCES

bicolor is available for door thickness ranges
from 38.1 to 78 mm.

When selecting the lock cylinder length, please
observe the overall height of the bicolor roses
(4 mm per side)

Individually configured matt edition fittings are
non-returnable.

- Item Number
- Colour lever handle
- Colour inlay rose
- Surface rose
- Square
- Door thickness
- Keyway

HEWI Spindles, installation jigs
see Catalogue Hardware 2018/19 page 199

Model 162.21PB

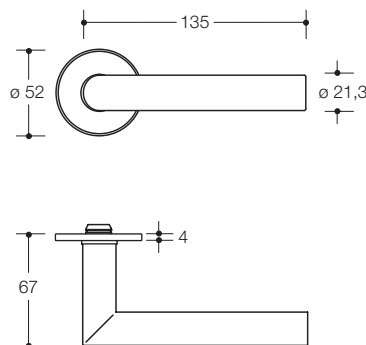
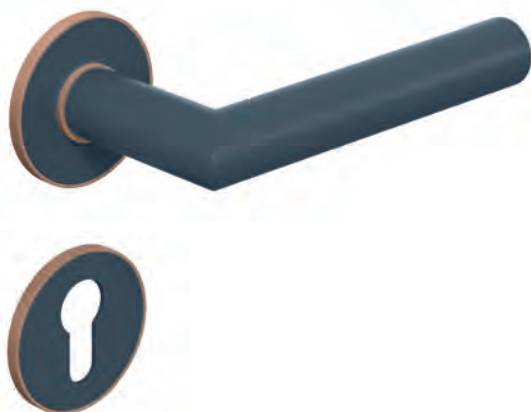

Lever handle 162.21PB with bicolor roses
Polyamide, matt available HEWI colours see below
 EN 1906 class 4
 DIN 18273 **F**

Fig.: Lever handle and inlay in 92 (anthracite grey) with rose in matt copper

	Stainless steel	Brass	PVD (Stainless steel) Copper	Black chrome
matt				
polished				

MATERIAL | COLOUR
 LEVER HANDLE, INLAY ROSE

Polyamide, matt
 99 92 90

MATERIAL | SURFACE
 ROSES

Stainless steel
 XA matt XC polished

PVD (Stainless steel)
Brass **Copper** **Black chrome**
 matt polished matt polished matt polished

CONFIGURATOR

Let your creativity run wild: With the help of the configurator, lever handles can be composed according to your personal preferences. Various lever handle models and materials allow countless combinations for individual unique specimen or continuous design objects, which underline the character of the building.

www.hewi.com/en/configurator

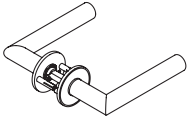
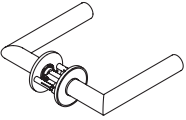
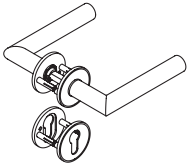
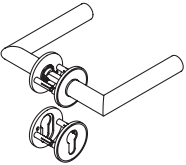
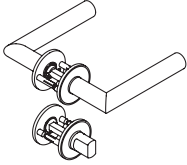
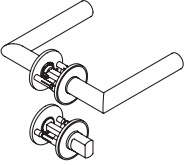
Model 162.21PB	Roses stainless steel matt or polished	Roses PVD (stainless steel) matt or polished (brass, copper, black chrome)
Standard door fitting without escutcheon class 4	 162PBIX06230	 162PBIV06230
Standard door fitting/ Fire door fitting class 4 class 4 F	 162PBIX01230 162PBIX11230	 162PBIV01230 162PBIV11230
Vacant/engaged fitting class 4	 162PBIX02230	 162PBIV02230

Escutcheon
for standard door fittings
306.23PBXI Stainless steel
306.23PBVI PVD (St. steel)

Rose with turn knob | FBM* (coin)
for vacant/engaged fittings
306.23PBXINR Stainless steel
306.23PBVINR PVD (St. steel)



*Latch and free/occupied indicator made of
matt polyamide

ORDERING INFORMATION

CROSS-REFERENCES

bicolor is available for door thickness ranges
from 38.1 to 78 mm.

When selecting the lock cylinder length, please
observe the overall height of the bicolor roses
(4 mm per side)

Individually configured matt edition fittings are
non-returnable.

- Item Number
- Colour lever handle
- Colour inlay rose
- Surface rose
- Square
- Door thickness
- Keyway

HEWI Spindles, installation jigs
see Catalogue Hardware 2018/19 page 199

Model 251.21PB

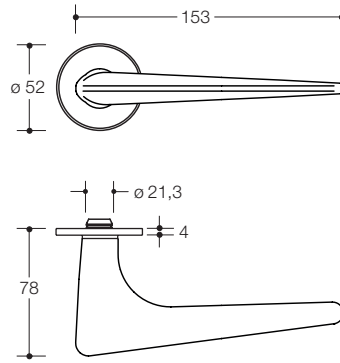

Lever handle 251.21PB with bicolor roses
Polyamide, matt available HEWI colours see below
 EN 1906 class 3

Fig.: Lever handle and inlay in 92 (anthracite grey) with rose in matt copper

	Stainless steel	Brass	PVD (Stainless steel) Copper	Black chrome
matt				
polished				

MATERIAL | COLOUR
 LEVER HANDLE, INLAY ROSE

MATERIAL | SURFACE
 ROSES

CONFIGURATOR

Stainless steel

XA matt XC polished

PVD (Stainless steel)

Brass **Copper** **Black chrome**
 matt polished matt polished matt polished

Polyamide, matt

99 92 90

Let your creativity run wild: With the help of the configurator, lever handles can be composed according to your personal preferences. Various lever handle models and materials allow countless combinations for individual unique specimen or continuous design objects, which underline the character of the building.

www.hewi.com/en/configurator

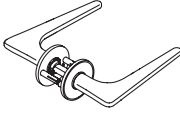
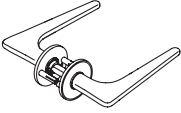
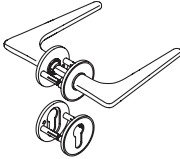
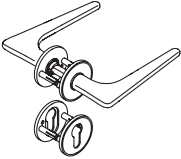
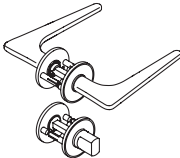
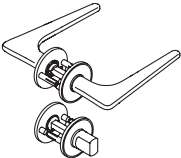
Model 251.21PB	Roses stainless steel matt or polished	Roses PVD (stainless steel) matt or polished (brass, copper, black chrome)
Standard door fitting without escutcheon class 3	 250PBIX06130	 250PBIV06130
Standard door fitting class 3	 250PBIX01130	 250PBIV01130
Vacant/engaged fitting class 3	 250PBIX02130	 250PBIV02130

Escutcheon
for standard door fittings
306.23PBXI Stainless steel
306.23PBVI PVD (St. steel)

Rose with turn knob | FBM* (coin)
for vacant/engaged fittings
306.23PBXINR Stainless steel
306.23PBVINR PVD (St. steel)



*Latch and free/occupied indicator made of
matt polyamide

ORDERING INFORMATION

CROSS-REFERENCES

bicolor is available for door thickness ranges
from 38.1 to 78 mm.

When selecting the lock cylinder length, please
observe the overall height of the bicolor roses
(4 mm per side)

Individually configured matt edition fittings are
non-returnable.

Item Number
Colour lever handle
Colour inlay rose
Surface rose
Square
Door thickness
Keyway

HEWI Spindles, installation jigs
see Catalogue Hardware 2018/19 page 199

Innovative mounting technology

Flat roses

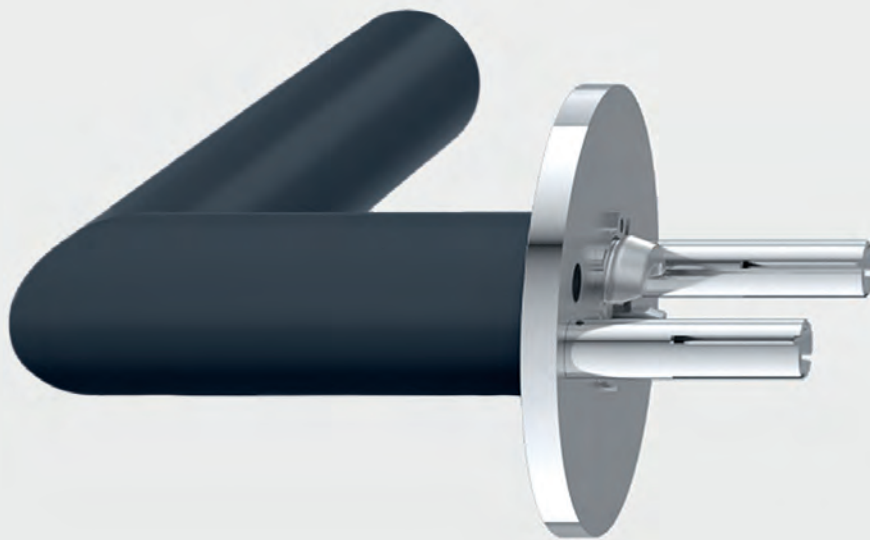

The innovative technology of flat roses not only enables a reduced design at the door, but also straightforward installation. To affix the flat roses, the latching sleeves and threaded bolts are plugged into each other, so that they latch together with tension-proof fixing. They are secured with the setscrew. This facilitates easy, problem-free installation and dismantling.

Despite the compact overall height of only 4 mm, the flat roses fulfil the requirements of EN 1906 in user category 4 for very high frequency of use and are thus suitable not only for the housing sector but also for office and commercial buildings and for public buildings. The fire protection requirements of DIN 18273 are also fulfilled by the fire door fitting set.



Easy installation

How easily the tool-free quick connection of the flat roses works is also shown by the installation video at:
www.hewi.com/en/flat-roses

Model 111PBR R-Technology

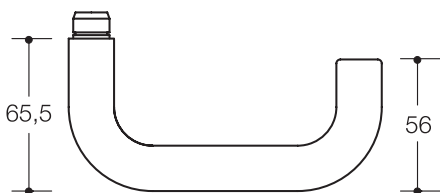
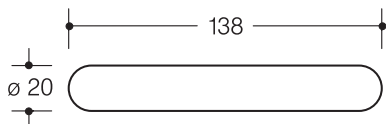













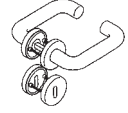

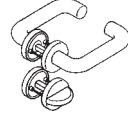

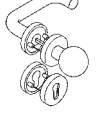
Lever handle 111PBR with roses or backplate
Polyamide, matt available HEWI colours see below
R-Technology EN 1906 class 4
DIN 18273 **F**
EN 179

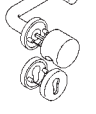
MATERIAL | COLOUR

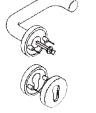
Polyamide, matt

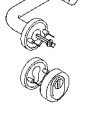
98 99 97 95 92 90

Model 111PBR	Roses 305.20../306.23	Backplate 230.20...
Standard door fitting/ Fire door fitting class 4   class 4  	 111PBR01.130 111PBR11.130	 111PBR01.110
Vacant/engaged fitting class 4	 111PBR02.130	
Apartment door fitting/Apartment fire door fitting class 4  	 111PBR13.133	
Apartment door fitting/Apartment fire door fitting class 4  	 111PBR13.132	
Half fitting with security escutcheon according to DIN 18257 ES1 class 4  	 111PBR22.130	
Half fitting with security escutcheon acc. to DIN 18257 ES1 and cylinder cover class 4  	 111PBR23.130	
Glass lever handle class 4	 111PBG01.130	 111PBG01.100

ORDERING INFORMATION

Item Number
Colour
Square
Door thickness
Keyway
If applicable distance (backplates)
If applicable emergency release (wc)

CROSS-REFERENCES



Standard door fitting
 see Catalogue Hardware 2018/19 page 179

Further fitting-variations can be assembled from separate components see **Components** page 24

HEWI Spindles, installation jigs
 see Catalogue Hardware 2018/19 page 199

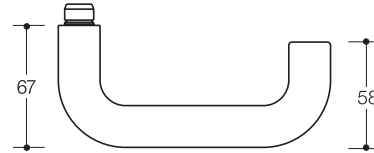
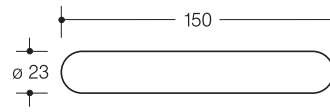

Model 111.23PBR R-Technology

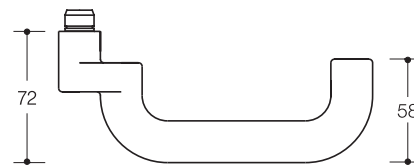
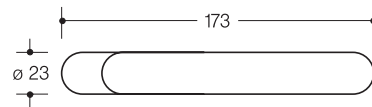

Lever handle 111.23PBR with roses or backplate
Polyamide, matt available HEWI colours see below
R-Technology EN 1906 class 4
DIN 18273 
EN 179 

Model 114.23PBR











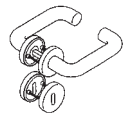

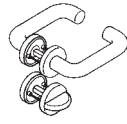
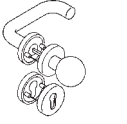

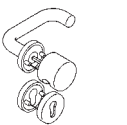

Lever handle 114.23PBR with roses
Polyamide, matt available HEWI colours see below
R-Technology EN 1906 class 4
DIN 18273 
EN 179 

MATERIAL | COLOUR

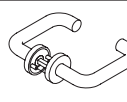
Polyamide, matt

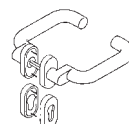

Model 111.23PBR	Roses 305.23../306.23	Backplate 230.23...
Standard door fitting/ Fire door fitting		
class 4 class 4	 111PBR01.230 111PBR11.230	111PBR01.210
Vacant/engaged fitting		
class 4	111PBR02.230	
Apartment door fitting/Apartment fire door fitting		
class 4 class 4	 111PBR03.233 111PBR13.233	
Apartment door fitting/Apartment fire door fitting		
class 4 class 4	 111PBR03.232 111PBR13.232	
Half fitting with security escutcheon according to DIN 18257 ES1		
class 4	 111PBR22.230	
Half fitting with security escutcheon acc. to DIN 18257 ES1 and cylinder cover		
class 4	 111PBR23.230	
Glass lever handle		
class 4	111PBG01.230	111PBG01.200

Model 114.23PBR	Roses 315.23../316...
Fitting for framed doors/ Fire door fitting for framed doors	
class 4	 111PBR11.440

ORDERING INFORMATION

- Item Number**
- Colour**
- Square**
- Door thickness**
- Keyway**
- If applicable distance (backplates)**
- If applicable emergency release (wc)**

CROSS-REFERENCES

Standard door fitting
see Catalogue Hardware 2018/19 page 179

Further fitting-variations can be assembled from separate components see **Components** page 24

HEWI Spindles, installation jigs
see Catalogue Hardware 2018/19 page 199

LEVER HANDLES

Lever handle
R-Technology, class 4
111PBR
111PBRLT







Lever handle
R-Technology, class 4
111.23PBR
111.23PBRLT





Lever handle
R-Technology, class 4
114.23PBR
114.23PBRLT







ROSES

Rose
R-Technology, class 4
305.20PBR 
305.20PBRKN 
305.23PBR 
305.23PBRKN 





Escutcheon/rose with turn knob
306.23PB
306.23PBKN
306.23PBFS 
306.23PBFSKN 
306.23PBNRKN



Rose
R-Technology
315.20PBR 
315.20PBRKN 
315.23PBR 
315.23PBRKN 



Escutcheon
316PBR
316PBRKN
316PBRFS 
316PBRFSKN 



KNOBS

Knob half fitting
R-Technology, class 4
111PBK.33
with round rose 305.23PBR
111PBK.43
with oval rose 315.23PBR



MATERIAL | COLOUR

Polyamide, matt



98 99 97 95 92 90

Item Number

Dimensions in mm / Specification



F

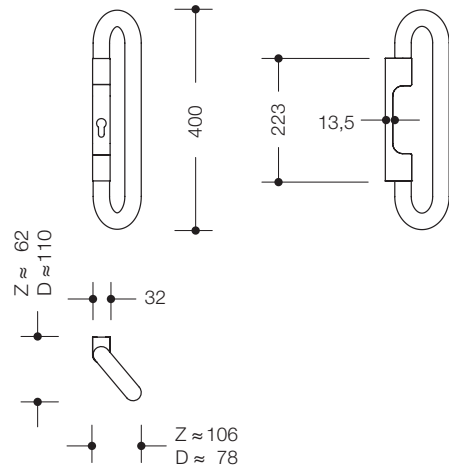

HEWI Push & pull handle set

- made of high-quality polyamide, matt, available HEWI colours see below left
- handle \varnothing 33 mm
- lower plate section of metal with polyamide caps
- plate thickness in lock cylinder area 13,5 mm
- supplied with screws and square spindle
- operation in the direction of door opening: Push
- operation in the opposite direction: Pull

111PBDG02

- with continuous spindle

111PBDG12

- with split spindle 72.3PS
- licensed for use in conjunction with fire and smoke doors to DIN 18273

111PBDG02D

- Push & pull handle set as half fitting: Push

111PBDG02Z

- Push & pull handle set as half fitting: Pull

Please note:

- maximum nut pivot angle of 40°
- unsuitable for inactive leaves
- suitable for use in inner- and protected outer areas

Opening direction of door (DIN)

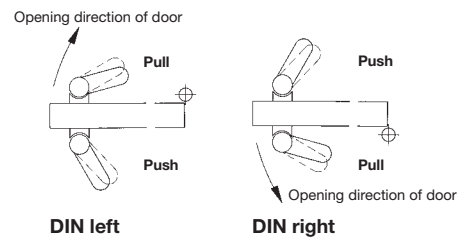

EMERGENCY | FRAMED DOORS FITTINGS

EN 179

F Fire protection

ORDERING INFORMATION

Item Number, colour

Opening direction of door (DIN)

Lock manufacturers: BKS, Fuhr, KfV

Keyway: PZ, KABA or BL

Distance, door thickness

Square: 8 mm or 9 mm

Measurement xa/xi (model with split spindle)

ADDITIONAL PRODUCTS

711BD... Symbol Push **page 50**

711BZ... Symbol Push **page 50**

Item Number

Dimensions in mm / Specification

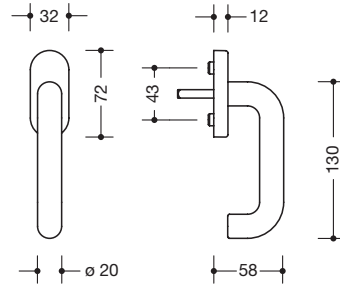

111PBFG.1

HEWI Window handle

- made of high-quality polyamide, matt
- handle ø 20 mm
- with corrosion resistant steel core, lever held by spring clip at 90°
- oval rose with support cams concealed screw mounting
- screw hole spacing 43 mm, spindle 7 mm square
- supplied without fixing screws

Available with 45° or 180° stop for night ventilation on request.

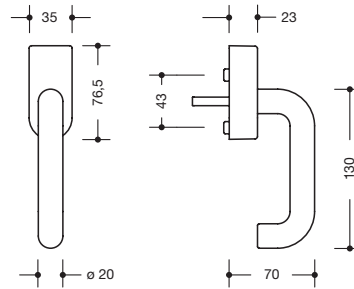

111PBFGA.1*

HEWI Window handle

- lockable, made of high-quality polyamide, matt
- handle ø 20 mm
- with corrosion resistant steel core, lever held by spring clip at 90°
- backplate with steel body and alignment lugs, fixing screws protected against unauthorized removal, snap on cover
- screw hole spacing 43 mm, spindle 7 mm square
- with special screws M5 and wood screws
- cylinder with 5 pins, lockable in all positions

111PBFGA.1K*

- do., for windows with tilt before turn function

* Tested to EN 13126 Part 3, fulfil the requirements of EN 1627-1630 for grade RC1-RC6 window elements.

MATERIAL | COLOUR

Polyamide, matt



If only the article number is given in the order, we assume the following standard option:

- Window handle (standard) „...FG...“ :**
preceding spindle length = 30 mm, latching = 90°
- Window handle lockable „...FGA...“ :**
preceding spindle length = 30 mm, latching = 90°,
Type of locking = keyed alike,
Keying number = freely selectable

ORDERING INFORMATION

Item Number

Colour

Spindle length: advice protruding spindle length

Opening direction of door (DIN): K-model

Type of locking: various locking type

Keying number: e.g. expansion of existing buildings

Item Number

Dimensions in mm / Specification



550.30BGKWL

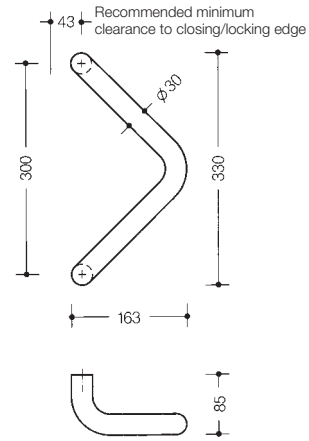

HEWI Pull handle \varnothing 30 mm

- made of high-quality polyamide, matt
- c to c 300 mm
- for one-sided and paired fixing



550.33BKSLT

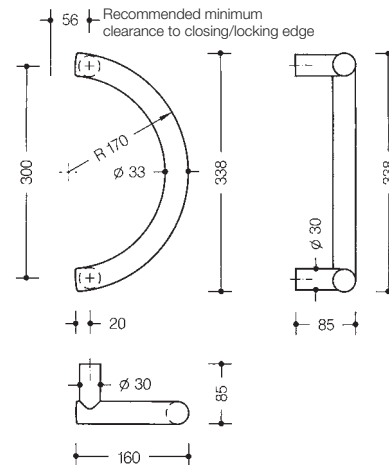

HEWI Pull handle \varnothing 33 mm

- made of high-quality polyamide, matt
- with corrosion resistant steel core
- supports \varnothing 30 mm
- c to c 300 mm
- for one-sided and paired fixing

Please note:

Rose fixing only possible with BA...33STGB! **page 30**

MATERIAL | COLOUR

ORDERING INFORMATION

Polyamide, matt



Item Number

Colour

Fixing type: one-sided/per pair: p. 30, 31

If applicable door thickness

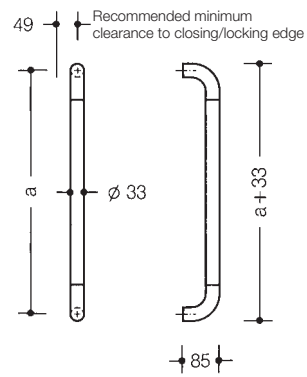

33.2010B

HEWI Pull handle ø 33 mm

- from rail system
- made of high-quality polyamide, matt with corrosion resistant steel core
- for one-sided and paired fixing

c to c	33.2010B
from (mm)	200
200-399	
400-499	
500-599	
600-699	
700-799	
800-899	
900-999	
1000-1099	
1100-1199	
1200-1299	
1300-1399	
1400-1499	
1500-1599	
1600-1699	
1700-1799	
1800-1899	
1900-1999	
2000-2099	
2100-2199	
to (mm)	2150

MATERIAL | COLOUR

Polyamide, matt



Item Number

Dimensions in mm / Specification



550.33BLT

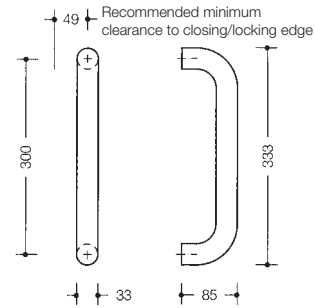

HEWI Pull handle \varnothing 33 mm

- made of high-quality polyamide, matt
- c to c 300 mm
- for one-sided and paired fixing



550.33BGKLT

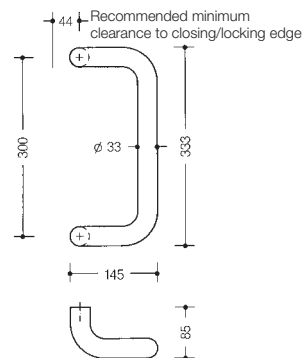

HEWI Pull handle \varnothing 33 mm

- made of high-quality polyamide, matt
- c to c 300 mm
- for one-sided and paired fixing



550.30BGKLT

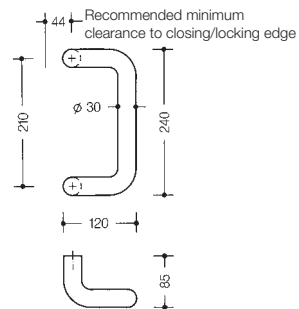

HEWI Pull handle \varnothing 30 mm

- made of high-quality polyamide, matt
- c to c 210 mm
- for one-sided and paired fixing

ORDERING INFORMATION

Item Number

Colour

Fixing type: one-sided/per pair: p. 30, 31

If applicable door thickness

If applicable c to c

Item Number

Specification

Fixing types for:
one-sided installation

→ Pull handles with roses

BA1...PAB

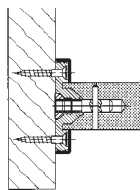

HEWI Fixing type 1...PAB

· for one-sided handle fixing from the front with matt polyamide roses

Not for use with handles with inclined supports.
Supplied without \varnothing 6 mm countersunk screws.

Please advise colour when ordering.

BA1.30PAB
BA1.33PAB

Support
 \varnothing 30 mm
 \varnothing 33 mm

Cap
 \varnothing 68 mm
 \varnothing 70 mm

Rose base
Polyamide, matt
Polyamide, matt

Handle mounting height
+ 8 mm
+ 6 mm

BA1...STGB

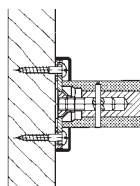

HEWI Fixing type 1...STGB

· for one-sided handle fixing from the front with steel rose base and matt polyamide roses

Not for use with handles with inclined supports.
Supplied without \varnothing 6 mm countersunk screws.

Please advise colour when ordering.

BA1.30STGB

Support
 \varnothing 30 mm

Cap
 \varnothing 70 mm separated

Rose base
Steel

Handle mounting height
+ 5 mm

Fixing types for:
installation per pair

→ Pull handles with roses

BA2...PAB

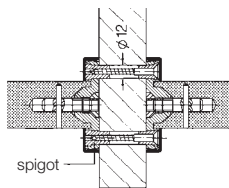

HEWI Fixing type 2...PAB

· for double-sided handle fixing from the front with matt polyamide roses

Not for use with handles with inclined supports.
Supplied without fixing screws.

Please advise colour when ordering.

BA2.30PAB
BA2.33PAB

Support
 \varnothing 30 mm
 \varnothing 33 mm

Cap
 \varnothing 68 mm
 \varnothing 70 mm

Rose base
Polyamide, matt
Polyamide, matt

Handle mounting height
+ 8 mm
+ 6 mm

BA2...STGB

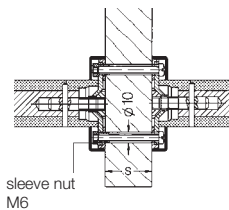

HEWI Fixing type 2...STGB

· for double-sided handle fixing from the front with steel rose base and matt polyamide roses

Not for use with handles with inclined supports.
Supplied without fixing screws M6.

Please advise colour when ordering.

BA2.30STGB

Support
 \varnothing 30 mm

Cap
 \varnothing 70 mm separated

Rose base
Steel

Handle mounting height
+ 5 mm

MATERIAL | COLOUR

ORDERING INFORMATION

Polyamide, matt



Item Number
Colour

Item Number

Dimensions in mm / Specification

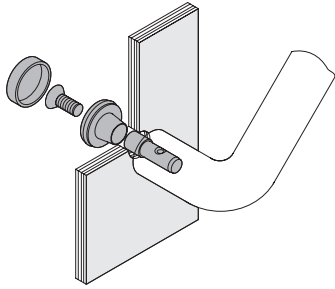

BA4.08.12B

HEWI Fixing type 4.08.12 for pull handles made of matt polyamide

- for rear-mounting of handle to glass using a blind rose fitting \varnothing 33 mm
- drill hole in door \varnothing 18 mm

Please advise colour when ordering.

Tools required

- hexagonal spanner SW5

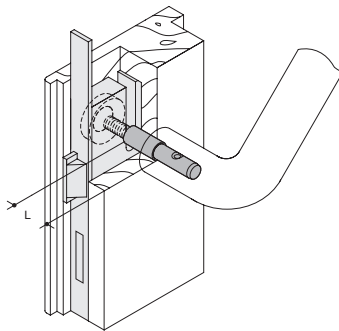

BA4.12.20B
BA4.20.30B
BA4.30.40B
BA4.40.50B
BA4.50.60B
BA4.60.70B
BA4.70.80B
BA4.80.90B

HEWI Fixing type 4... for pull handles made of matt polyamide

- for rear-mounting of handle to solid wood, plastic and 1 to 3-chamber aluminium sections using a blind rose fitting \varnothing 33 mm
- drill hole in door \varnothing 12 mm, dimension L = insert depth

dimension L door thickness

6 mm	12-20 mm
6 mm	20-30 mm
6 mm	30-40 mm
6 mm	40-50 mm
16 mm	50-60 mm
16 mm	60-70 mm
16 mm	70-80 mm
16 mm	80-90 mm

Please advise colour when ordering.

Tools required

- hexagonal spanner SW5

Mounting instructions

can also be used for securing using mortice locks.

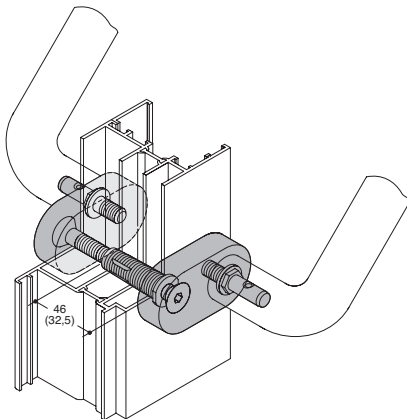

BA5.0.35.40B
BA5.0.40.45B
BA5.0.45.50B
BA5.0.50.55B
BA5.0.55.70B
BA5.0.70.85B

HEWI Fixing type 5.0...

- for double-sided fixing to solid wood, synthetic material and 2 to 3 chamber aluminium sections, fire protection profiles made of steel, stainless steel or aluminium, drill hole in door \varnothing 14 mm

door thickness 35-40 mm

door thickness 40-45 mm

door thickness 45-50 mm

door thickness 50-55 mm

door thickness 55-70 mm

door thickness 70-85 mm

Please advise colour when ordering.

Rose fixing: height of handle + 18 mm

A safety distance of 25 mm to the closing edge is ensured according to accident prevention regulations for schools GUV – VS 1 and guidelines for kindergartens – construction and equipment GUV – SR 2002

Tools required

- open jawed spanners SW19 and hexagonal spanner SW6 / SW10

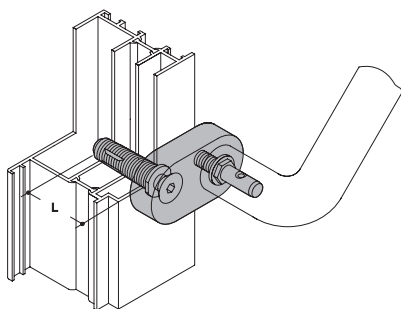

BA5.0B

HEWI Fixing type 5.0

- for securing handles on one side to solid wood, plastic and 2 to 3 chamber aluminium sections, fire protection profiles made of steel, stainless steel or aluminium

- drill hole in door \varnothing 14 mm

- dimension L = 46 mm, door thickness > 50 mm

Please advise colour when ordering.

Rose fixing: height of handle + 18 mm

A safety distance of 25 mm to the closing edge is ensured according to accident prevention regulations for schools GUV – VS 1 and guidelines for kindergartens – construction and equipment GUV – SR 2002

Tools required

- hexagonal spanner SW6 and SW10, open jawed spanners SW19

Item Number

Dimensions in mm / Specification



801.90B010

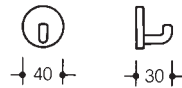

HEWI Single hook

- concealed screw fitting to prevent unauthorised removal
- 30 mm deep, rose ø 40 mm
- made of high-quality polyamide, matt



801.90B020

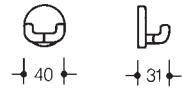

HEWI Double hook

- concealed screw fitting to prevent unauthorised removal
- 31 mm deep, rose ø 40 mm
- made of high-quality polyamide, matt



477.90B010

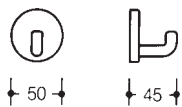

HEWI Single hook

- concealed screw fitting to prevent unauthorised removal
- 45 mm deep, rose ø 50 mm
- made of high-quality polyamide, matt



477.90B025

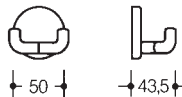

HEWI Double hook

- concealed screw fitting to prevent unauthorised removal
- 43,5 mm deep, rose ø 50 mm
- made of high-quality polyamide, matt



477.90B030

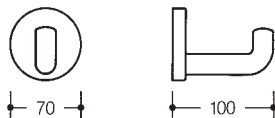

HEWI Single hook

- concealed screw fitting to prevent unauthorised removal
- 100 mm deep, rose ø 70 mm
- made of high-quality polyamide, matt

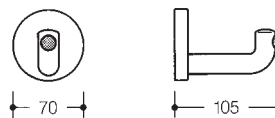

477.90B035

HEWI Single hook

- do., 105 mm deep
- with black elastic matt door stops

MATERIAL | COLOUR

Polyamide, matt

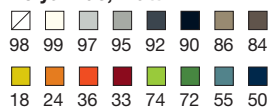

Item Number

Dimensions in mm / Specification



477.90B015

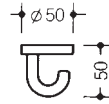

HEWI Hook

- can be installed under shelf
- concealed screw fitting to prevent unauthorised removal
- 50 mm high, rose \varnothing 50 mm
- made of high-quality polyamide, matt



477.90B040

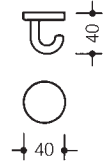

HEWI Hook

- can be installed under shelf
- concealed screw fitting to prevent unauthorised removal
- 40 mm high, rose \varnothing 40 mm
- made of high-quality polyamide, matt



477.90B050

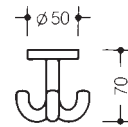

HEWI Triple hook

- rotatable hook, for screw-mounting from below with 4 mm countersunk, screw or for through-mounting from above with M4 threaded screws and square-head nuts
- rose \varnothing 50 mm, 70 mm high
- made of high-quality polyamide, matt

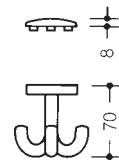

477.90B051

477.90B052

HEWI Triple hook

- rotatable hook, with counter plate for through-mounting from below, with three 4 mm countersunk wood screws
- rose \varnothing 50 mm
- made of high-quality polyamide, matt

for panels up to 15 mm thickness

for panels more than 15 mm thickness

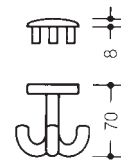

ORDERING INFORMATION

Item Number
Colour

Item Number

Dimensions in mm / Specification



477.90B060

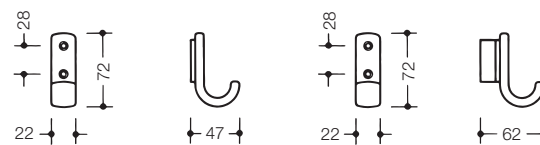

HEWI Coat and hat hook

- 72 mm high, 22 mm wide and 47 mm deep
- centre to centre 28 mm
- made of high-quality polyamide, matt

477.90B061

HEWI Coat and hat hook

- do., with spacer, 62 mm deep



477.90B070

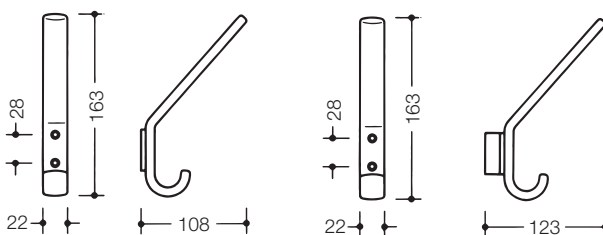

HEWI Coat and hat hook

- 163 mm high, 22 mm wide and 108 mm deep
- centre to centre 28 mm
- made of high-quality polyamide, matt

477.90B071

HEWI Coat and hat hook

- do., with spacer, 123 mm deep



477.90B080

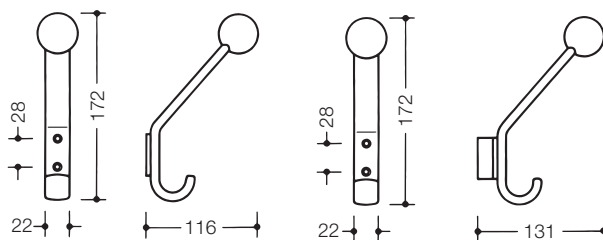

HEWI Coat and hat hook

- with ball top
- 172 mm high, 22 mm wide and 116 mm deep
- centre to centre 28 mm
- made of high-quality polyamide, matt

477.90B081

HEWI Coat and hat hook

- do., with spacer, 131 mm deep

MATERIAL | COLOUR

Polyamide, matt

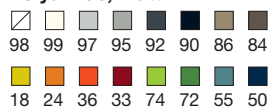

Item Number

Dimensions in mm / Specification



801.90B030

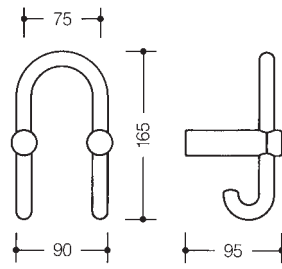

HEWI Double coat hook

- hooks face inwards towards wall
- centre to centre 75 mm, 165 high, projection 95 mm
- made of high-quality polyamide, matt

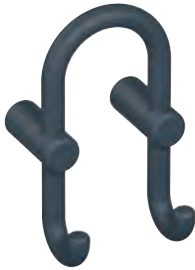

801.90B040

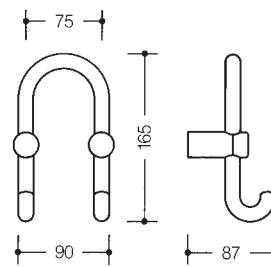

HEWI Double coat hook

- hooks face inwards towards wall
- centre to centre 75 mm, 165 high, projection 87 mm
- made of high-quality polyamide, matt



570.1B

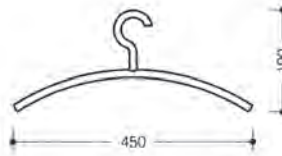

HEWI Coat hanger

- \varnothing 15 mm, suitable for HEWI rails \varnothing 33 mm
- made of high-quality polyamide, matt
- with fixed hook

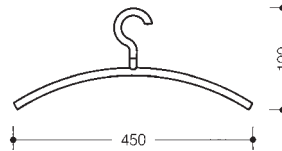

570.3B

HEWI Coat hanger

- do., with rotating hook with locking points at 90° intervals

ORDERING INFORMATION

Item Number
Colour

Item Number

Dimensions in mm / Specification



548.74B

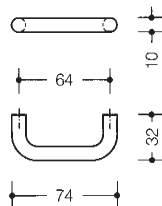

HEWI Furniture handle ø 10 mm

- made of high-quality polyamide, matt
- centre to centre 64 mm, 32 mm deep
- bolt through fixing



548.86B

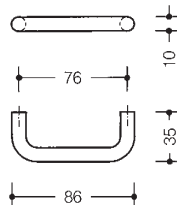

HEWI Furniture handle ø 10 mm

- made of high-quality polyamide, matt
- centre to centre 76 mm, 35 mm deep
- bolt through fixing



548.106B

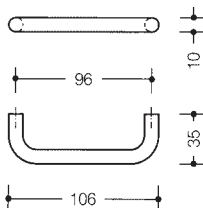

HEWI Furniture handle ø 10 mm

- made of high-quality polyamide, matt
- centre to centre 96 mm, 35 mm deep
- bolt through fixing



548.110B

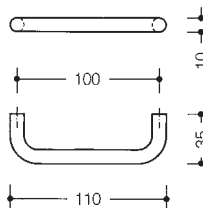

HEWI Furniture handle ø 10 mm

- made of high-quality polyamide, matt
- centre to centre 100 mm, 35 mm deep
- bolt through fixing

MATERIAL | COLOUR

Polyamide, matt

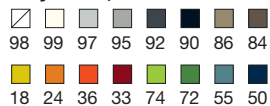

Item Number

Dimensions in mm / Specification



548.138B

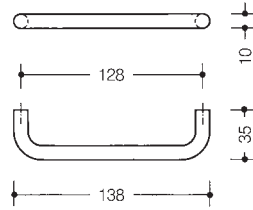

HEWI Furniture handle ø 10 mm

- made of high-quality polyamide, matt
- centre to centre 128 mm, 35 mm deep
- bolt through fixing



548RD42B

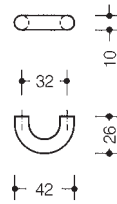

HEWI Furniture handle ø 10 mm

- made of high-quality polyamide, matt
- centre to centre 32 mm, 26 mm deep
- bolt through fixing



548RD50B

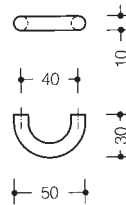

HEWI Furniture handle ø 10 mm

- made of high-quality polyamide, matt
- centre to centre 40 mm, 30 mm deep
- bolt through fixing



548.01B



HEWI Backplate

- made of high-quality polyamide, matt, ø 16 mm
- rose fixing: high furniture handles + 2,5 mm
- available only in pairs

548.02B

HEWI Counter washer

- made of high-quality polyamide, matt, ø 16 mm
- rose fixing: high furniture handles + 3,5 mm
- available only in pairs

ORDERING INFORMATION

Item Number
Colour

Item Number

Dimensions in mm / Specification



548.13B96

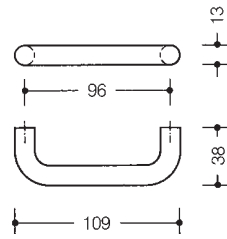

HEWI Furniture handle ø 13 mm

- made of high-quality polyamide, matt
- centre to centre 96 mm, 38 mm deep
- bolt through fixing



548.13B128

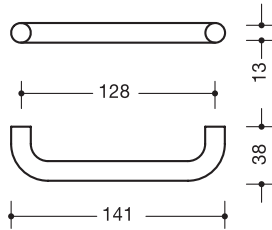

HEWI Furniture handle ø 13 mm

- made of high-quality polyamide, matt
- centre to centre 128 mm, 38 mm deep
- bolt through fixing



548.13B192

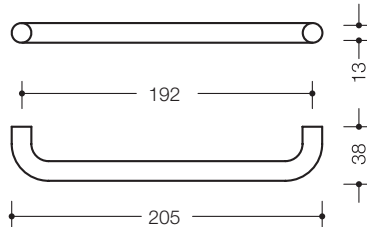

HEWI Furniture handle ø 13 mm

- made of high-quality polyamide, matt
- centre to centre 192 mm, 38 mm deep
- bolt through fixing

MATERIAL | COLOUR

Polyamide, matt

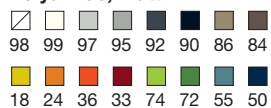

Item Number

Dimensions in mm / Specification



548.16B192

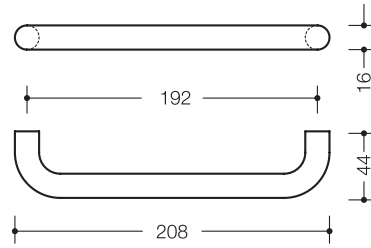

HEWI Furniture handle ø 16 mm

- made of high-quality polyamide, matt
- centre to centre 192 mm, 44 mm deep
- bolt through fixing



548.16B288

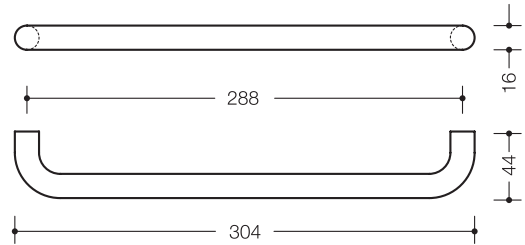

HEWI Furniture handle ø 16 mm

- made of high-quality polyamide, matt
- centre to centre 288 mm, 44 mm deep
- bolt through fixing



548.13BRS

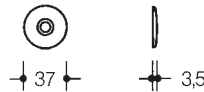

HEWI Backplate

- for furniture handles ø 13 mm
- made of high-quality polyamide, matt, ø 37 mm
- rose fixing: high furniture handles + 2,5 mm
- available only in pairs



548.13BH

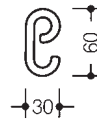

HEWI Hook

- made of high-quality polyamide, matt
- for furniture handles 548.13B...

ORDERING INFORMATION

Item Number
Colour

Item Number

Dimensions in mm / Specification

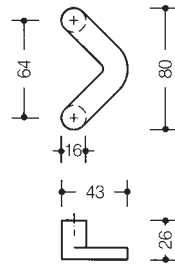

548.17B64GKW

HEWI Furniture handle

- made of high-quality polyamide, matt
- supports ø 16 mm, 26 mm deep
- centre to centre 64 mm
- bolt through fixing

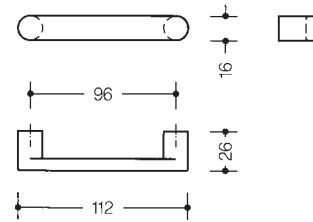

548.17B96
548.17B96.4

HEWI Furniture handle

- made of high-quality polyamide, matt
- supports ø 16 mm, 26 mm deep
- centre to centre 96 mm
- bolt through fixing
- bolt through fixing with screw cap

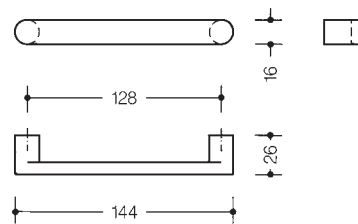
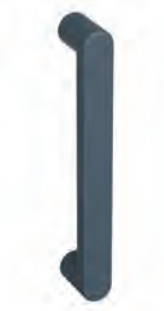

548.17B128
548.17B128.4

HEWI Furniture handle

- made of high-quality polyamide, matt
- supports ø 16 mm, 26 mm deep
- centre to centre 128 mm
- bolt through fixing
- bolt through fixing with screw cap

MATERIAL | COLOUR

Polyamide, matt

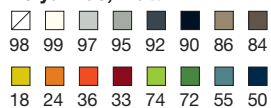

Item Number

Dimensions in mm / Specification



111BG.1
111BG.21
111BG
111BG.4
111BG.6
111BG.7

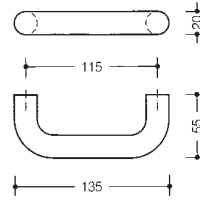

HEWI Furniture handle ø 20 mm

- made of high-quality polyamide, matt
- centre to centre 115 mm, 55 mm deep
- with rose fixing
- pair, with rose fixing
- bolt through fixing
- bolt through fixing with screw cap
- with concealed fixing front fixing
- pair, with concealed fixing



111.250BG.1
111.250BG.21
111.250BG
111.250BG.4
111.250BG.6
111.250BG.7

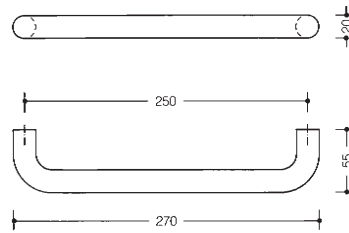

HEWI Furniture handle ø 20 mm

- made of high-quality polyamide, matt
- centre to centre 250 mm, 55 mm deep
- with rose fixing
- pair, with rose fixing
- bolt through fixing
- bolt through fixing with screw cap
- with concealed fixing front fixing
- pair, with concealed fixing



111.23BG.1
111.23BG.21
111.23BG
111.23BG.4
111.23BG.6
111.23BG.7

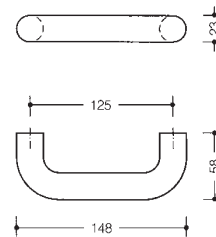

HEWI Furniture handle ø 23 mm

- made of high-quality polyamide, matt
- centre to centre 125 mm, 58 mm deep
- with rose fixing
- pair, with rose fixing
- bolt through fixing
- bolt through fixing with screw cap
- with concealed fixing front fixing
- pair, with concealed fixing

ORDERING INFORMATION

CROSS-REFERENCES

Item Number
 Colour

→ HEWI Fixing types **page 47**

Item Number

Dimensions in mm / Specification



562.10B64

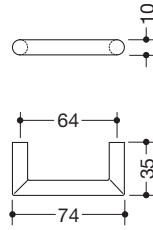

HEWI Furniture handle ø 10 mm

- made of high-quality polyamide, matt
- centre to centre 64 mm, 35 mm deep
- bolt through fixing



562.10B96

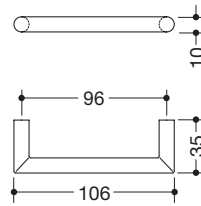

HEWI Furniture handle ø 10 mm

- made of high-quality polyamide, matt
- centre to centre 96 mm, 35 mm deep
- bolt through fixing



562.10B128

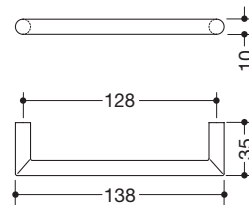

HEWI Furniture handle ø 10 mm

- made of high-quality polyamide, matt
- centre to centre 128 mm, 35 mm deep
- bolt through fixing

MATERIAL | COLOUR

Polyamide, matt

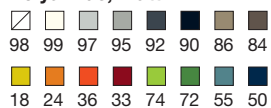

Item Number

Dimensions in mm / Specification



562.13B96

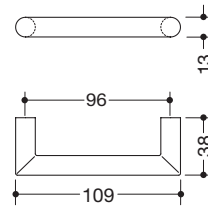

HEWI Furniture handle ø 13 mm

- made of high-quality polyamide, matt
- centre to centre 96 mm, 38 mm deep
- bolt through fixing



562.13B128

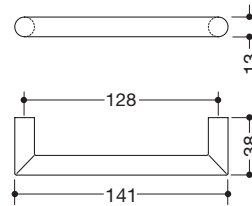

HEWI Furniture handle ø 13 mm

- made of high-quality polyamide, matt
- centre to centre 128 mm, 38 mm deep
- bolt through fixing



562.13B192

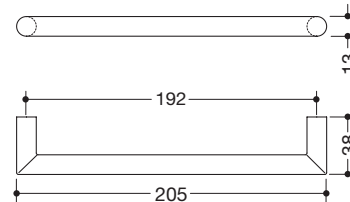

HEWI Furniture handle ø 13 mm

- made of high-quality polyamide, matt
- centre to centre 192 mm, 38 mm deep
- bolt through fixing

ORDERING INFORMATION

CROSS-REFERENCES

Item Number
Colour

- HEWI Fixing types **page 47**
- Furniture handles, polished **from page 58**

Item Number

Dimensions in mm / Specification



547.15B

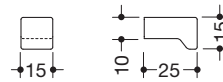

HEWI Cupboard knob

- made of high-quality polyamide, matt
- 15 mm wide, 15 mm high, 25 mm deep
- bolt through fixing



547.32B1

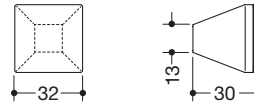

HEWI Cupboard knob

- made of high-quality polyamide, matt
- 32 mm wide, 32 mm high, 30 mm deep
- bolt through fixing



547.32B2

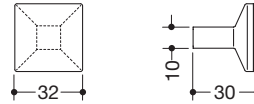

HEWI Cupboard knob

- made of high-quality polyamide, matt
- 32 mm wide, 32 mm high, 30 mm deep
- bolt through fixing



547.32B3

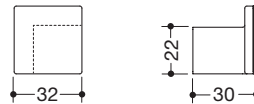

HEWI Cupboard knob

- made of high-quality polyamide, matt
- 32 mm wide, 32 mm high, 30 mm deep
- bolt through fixing



547.32B4

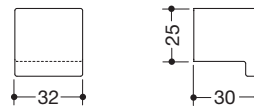

HEWI Cupboard knob

- made of high-quality polyamide, matt
- 32 mm wide, 32 mm high, 30 mm deep
- bolt through fixing

MATERIAL | COLOUR

CROSS-REFERENCES

Polyamide, matt

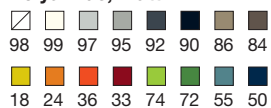

→ Cupboard knobs, polished **page 57**

Item Number

Dimensions in mm / Specification

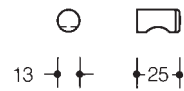
**557.13B****HEWI Cupboard knob**

- made of high-quality polyamide, matt
- ø 13 mm, 25 mm deep
- bolt through fixing

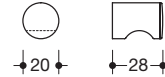
**557.20B****HEWI Cupboard knob**

- made of high-quality polyamide, matt
- ø 20 mm, 28 mm deep
- bolt through fixing

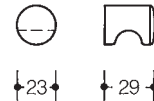
**557.23B****HEWI Cupboard knob**

- made of high-quality polyamide, matt
- ø 23 mm, 29 mm deep
- bolt through fixing

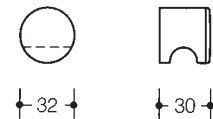

557.32B
557.32B.4
557.32B.6
557.32B.7

557.32KB**HEWI Cupboard knob**

- made of high-quality polyamide, matt
- ø 32 mm, 30 mm deep
- bolt through fixing
- bolt through fixing with screw cap
- for concealed front fixing
- pair, for concealed fixing

HEWI Knob

- for knob cylinders
- made of high-quality polyamide, matt, ø 32 mm, 30 mm deep
- from the leading cylinder manufacturers
- please indicate manufacturer and cylinder type when ordering

ORDERING INFORMATION**CROSS-REFERENCES**

Item Number
Colour

→ HEWI Fixing types **page 47**

Item Number

Dimensions in mm / Specification



557.50B
557.50B.6
557.50B.7

557.50KB

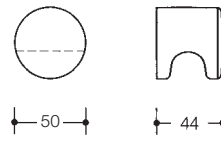

HEWI Cupboard knob

- made of high-quality polyamide, matt
- ø 50 mm, 44 mm deep
- bolt through fixing
- for concealed front fixing
- pair, for concealed fixing

HEWI Knob

- for knob cylinders
- made of high-quality polyamide, matt, ø 50 mm, 44 mm deep
- available as square socket option 7 or 8 mm and ø 10 mm (in case of order, please indicate)



557.55B
557.55B.6
557.55B.7

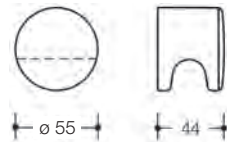

HEWI Cupboard knob

- made of high-quality polyamide, matt
- ø 55 mm, 44 mm deep
- bolt through fixing
- for concealed front fixing
- pair, for concealed fixing



559.23B

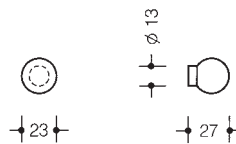

HEWI Cupboard knob

- made of high-quality polyamide, matt
- ø 23 mm, neck ø 13 mm, 27 mm deep
- bolt through fixing

MATERIAL | COLOUR

Polyamide, matt

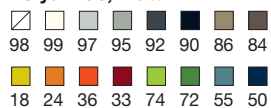

Item Number

Specification

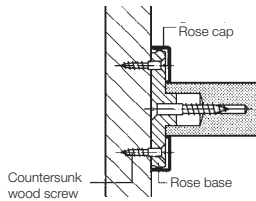

BA20.1B
BA23.1B

HEWI Fixing type 1

- concealed front fixing with rose \varnothing 52 mm
- rose fixing: high furniture handles + 6,7 mm
- countersunk screws not supplied

- for furniture handles \varnothing 20 mm
- for furniture handles \varnothing 23 mm

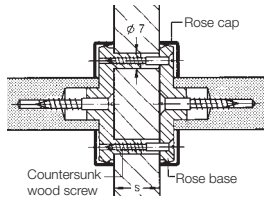

BA20.21B
BA23.21B

HEWI Fixing type 21

- fixing per pair on wood with roses \varnothing 52 mm
- rose fixing: high furniture handles + 13,4 mm
- countersunk screws not supplied
- please note: screws \varnothing 3,5 x (wall thickness + 10)

- for furniture handles \varnothing 20 mm
- for furniture handles \varnothing 23 mm

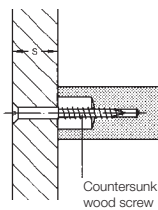

Standard

HEWI Fixing type 3

- bolt through fixing
- countersunk screws not supplied

Please note:

- 111... : screws \varnothing 5 x (wall thickness + 30)
- 547..., 548..., 557..., 562... : screws \varnothing 4 x (wall thickness + 15)
- 559... : screws \varnothing 4 x (wall thickness + 20)

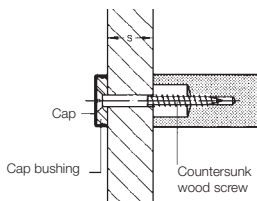

BA17.4B

BA20.4B

BA23.4B

HEWI Fixing type 4

- bolt through fixing with screw cap
- countersunk screws not supplied

Please note:

- 111... : screws \varnothing 5 x (wall thickness + 35)
- 548... : screws \varnothing 4 x (wall thickness + 20)
- 557... : screws \varnothing 4 x (wall thickness + 20)

- with screw cap \varnothing 16 x 4,7 mm
- e.g. for furniture handles 548... screws \varnothing 4 x (wall thickness + 20)

- with screw cap \varnothing 20 x 5 mm
- e.g. for furniture handles 111... screws \varnothing 5 x (wall thickness + 35)

- with screw cap \varnothing 23,5 x 5,6 mm
- e.g. for furniture handles 111.23... screws \varnothing 5 x (wall thickness + 35)

...6

HEWI Fixing type 6

- concealed front fixing
- countersunk screws not supplied

...7

HEWI Fixing type 7

- fixing per pair on wood
- countersunk screws not supplied

Please note:

- 111... : screws \varnothing 5 x (wall thickness + 40)
- 548... : screws \varnothing 4 x (wall thickness + 25)
- 557... : screws \varnothing 4 x (wall thickness + 25)

ORDERING INFORMATION

Item Number
Colour

CROSS-REFERENCES

Fixing types for:

- ← Furniture handles
- 548.13B... **page 38**
- 548.16B... **page 39**
- 548.17B... **page 40**
- ← Furniture handles 111...BG **page 41**
- ← Cupboard knobs 557..B... **from page 45**

Item Number

Dimensions in mm / Specification



535.42MLB

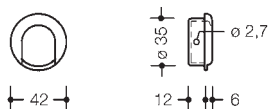

HEWI Flush pull

- made of high-quality polyamide, matt
- recessed 35 mm
- recessed depth 12 mm



535.75MLB

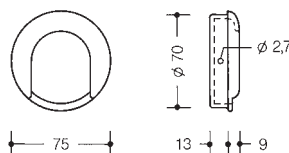

HEWI Flush pull

- made of high-quality polyamide, matt
- recessed 70 mm
- recessed depth 13 mm



538.60MLB

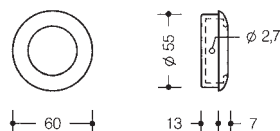

HEWI Flush pull

- made of high-quality polyamide, matt
- recessed 55 mm
- recessed depth 13 mm



538.75MLB

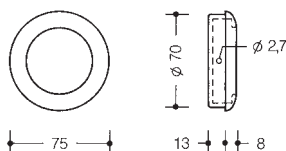

HEWI Flush pull

- made of high-quality polyamide, matt
- recessed 70 mm
- recessed depth 13 mm



538.90MLB

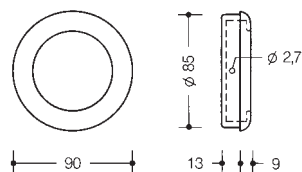

HEWI Flush pull

- made of high-quality polyamide, matt
- recessed 85 mm
- recessed depth 13 mm

MATERIAL | COLOUR

Polyamide, matt

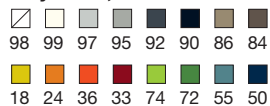

Item Number

Dimensions in mm / Specification



542B

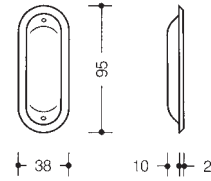

HEWI Flush pull

- made of high-quality polyamide, matt
- recessed dimensions 82 x 30 mm
- recessed depth 10 mm



539B

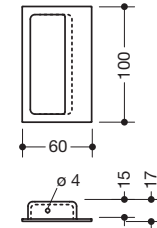

HEWI Flush pull

- made of high-quality polyamide, matt
- recessed dimensions 94 x 42 mm
- recessed depth 15 mm



544.54B120

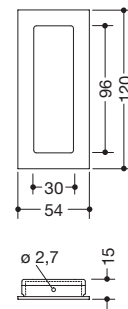

HEWI Flush pull

- made of high-quality polyamide, matt
- recessed dimensions 114,5 x 48,5 mm
- recessed depth 13 mm



544.60B

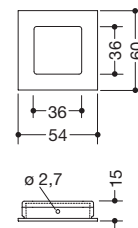

HEWI Flush pull

- made of high-quality polyamide, matt
- recessed dimensions 54,5 x 54,5 mm
- recessed depth 13 mm

ORDERING INFORMATION

CROSS-REFERENCES

Item Number
Colour

→ Flush pulls, polished **page 59**

Item Number

Dimensions in mm / Specification



801.91B010

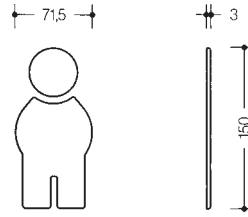

HEWI Symbol male

- 71,5 mm wide, 150 mm high and 3 mm thick
- self-adhesive back, made of high-quality polyamide, matt



801.91B020

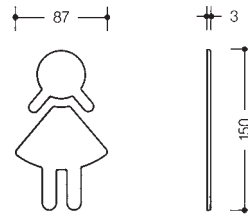

HEWI Symbol female

- 87 mm wide, 150 mm high and 3 mm thick
- self-adhesive back, made of high-quality polyamide, matt



801.91B030

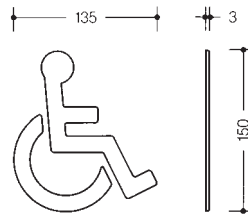

HEWI Symbol accessibility

- 135 mm wide, 150 mm high and 3 mm thick
- self-adhesive back, made of high-quality polyamide, matt



711BD

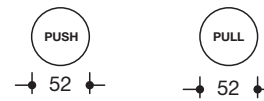

HEWI Symbol push

- self-adhesive back, ø 52 mm, 2 mm thick
- made of high-quality polyamide, matt



711BZ

HEWI Symbol pull

- dto.

Also available in other languages.

MATERIAL | COLOUR

Polyamide, matt



98 99 97 95 92 90

Item Number

Dimensions in mm / Specification



610B

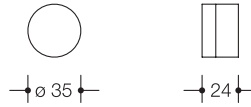

HEWI Door stop

- made of high-quality polyamide, matt, $\varnothing 35$ mm, 24 mm long
- with black elastic matt buffer
- supplied with fixing material



611.30B

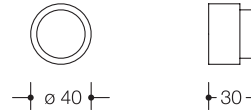

HEWI Door stop

- made of high-quality polyamide, matt, $\varnothing 40$ mm, 30 mm long
- with spring-mounted black elastic matt buffer
- supplied with fixing material



615B



HEWI Door stop

- made of high-quality polyamide, matt, $\varnothing 52$ mm, 42,5 mm high
- with black elastic matt buffer
- supplied with fixing material



625B



HEWI Door stop

- made of high-quality polyamide, matt, $\varnothing 85$ mm, 22,5 mm high
- with spring-mounted black elastic matt buffer
- supplied with fixing material

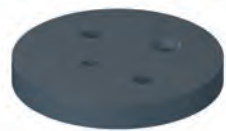

625.1B



HEWI Spacer for door stop

- made of high-quality polyamide, matt, $\varnothing 85$ mm
- increases the buffer height by 11 mm
- with locked anti-twist protection

ORDERING INFORMATION

Item Number
Colour

Item Number

Dimensions in mm / Specification



B8107B.100

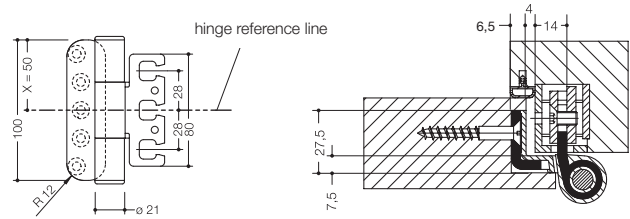

HEWI Triple-roll hinge

- for rebated doors (up to 100 kg)
- in wood-, steel- and aluminium frames, suitable for three-dimensionally adjustable retaining elements system VN and VZK
- made of high-quality matt polyamide with supporting steel frame made from galvanised 4 mm sheet steel and closed hinge roll
- with stainless steel pin, maintenance-free polyamide low friction bearing and polyamide caps for concealing the screw
- cutting size 6,5 mm



B8107B.160

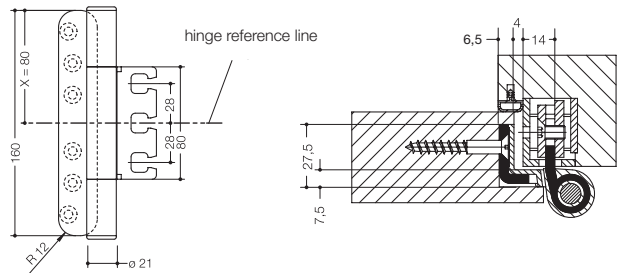

HEWI Triple-roll hinge

- for rebated doors (up to 180 kg)
- in wood-, steel- and aluminium frames, suitable for three-dimensionally adjustable retaining elements system VN and VZK
- made of high-quality matt polyamide with supporting steel frame made from galvanised 4 mm sheet steel and closed hinge roll
- with stainless steel pin, maintenance-free polyamide low friction bearing and polyamide caps for concealing the screw
- cutting size 6,5 mm



B8107B.160FS

- for rebated doors according to EN 1935
- four additional steel bushes prevent the stainless steel pin from slipping in the event of a fire

MATERIAL | COLOUR

Polyamide, matt



NORM



HEWI Triple-roll hinges marked with „FS“ are tested and proofed according EN 1935. The hinges are suitable for applying in fire- and smoke protective doors, as well as escape and emergency doors.

Hinges B...160FS

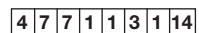

Item Number

Dimensions in mm / Specification



B9107B.100

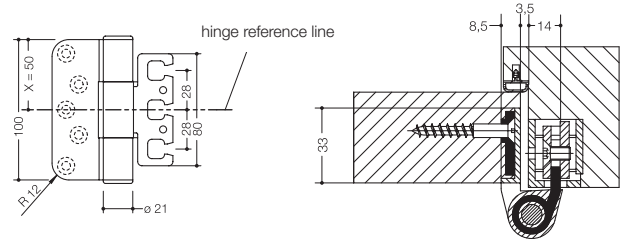

HEWI Triple-roll hinge

- for flush doors (up to 100 kg)
- in wood-, steel- and aluminium frames, suitable for three-dimensionally adjustable retaining elements system VN and VZK
- made of high-quality matt polyamide with supporting steel frame made from galvanised 4 mm sheet steel and closed hinge roll
- with stainless steel pin, maintenance-free polyamide low friction bearing and polyamide caps for concealing the screw
- cutting size 8,5 mm

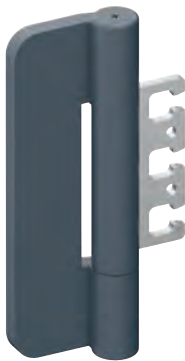

B9107B.160

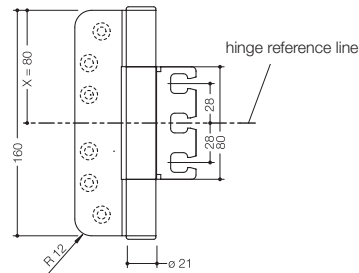

HEWI Triple-roll hinge

- for flush doors (up to 180 kg)
- in wood-, steel- and aluminium frames, suitable for three-dimensionally adjustable retaining elements system VN and VZK
- made of high-quality matt polyamide with supporting steel frame made from galvanised 4 mm sheet steel and closed hinge roll
- with stainless steel pin, maintenance-free polyamide low friction bearing and polyamide caps for concealing the screw
- cutting size 8,5 mm



B9107B.160FS

- for flush doors according to EN 1935
- four additional steel bushes prevent the stainless steel pin from slipping in the event of a fire

DECLARATION OF PERFORMANCE

ORDERING INFORMATION

The declaration of performance according to 305/2011 for hinges with CE-mark can be downloaded under www.hewi.com or can be requested under +49 5691/82-300 or international@hewi.com.

Item Number
Colour

Item Number

Dimensions in mm / Specification



B9505B.50L
B9505B.50R

AF50.1B

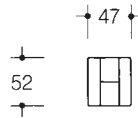

HEWI Screw-on hinge

- for flush doors (up to 40 kg) in wood-, steel- and aluminium frames
- made of high-quality polyamide, matt
- with supporting steel frame made from galvanised sheet steel
- maintenance-free polyamide plain bearing
- polyamide caps for concealing the screw

DIN left
DIN right

HEWI Hinge spacers, 1 mm thick

- made of high-quality polyamide, matt
- to compensate for forward or receding door



B9505B.75LK
B9505B.75RK

B9505B.75LF
B9505B.75RF

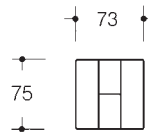

HEWI Screw-on hinge

- for flush doors (up to 80 kg) in wood-, steel- and aluminium frames
- made of high-quality polyamide, matt
- with supporting steel frame made from galvanised sheet steel
- maintenance-free polyamide plain bearing
- polyamide caps for concealing the screw

DIN left
DIN right

HEWI Screw-on hinge (spring hinge)

- for partition walls (up to 25 kg)
- made of high-quality polyamide, matt with corrosion resistant steel core

DIN left, spring hinge
DIN right, spring hinge

Per door 3 hinges are necessary.
Example: DIN left: 2 x B9505.75LK, 1 x B9505.75LF

Tools required

- hexagonal spanner SW6 and SW2,5

HEWI Fixing material for partition walls

- consisting of 4 screws and plugs made of brass M6

door thickness up to 13 mm
door thickness over 13 mm

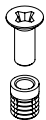

BM1182
BM1183

AF75.2B

HEWI Hinge spacers, 2 mm thick

- made of high-quality polyamide, matt
- to compensate for forward or receding door

MATERIAL | COLOUR

ORDERING INFORMATION

Polyamide, matt



Item Number
Colour

Cabinet hardware

Consistent equipment



Item Number

Dimensions in mm / Specification

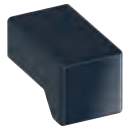

547.15

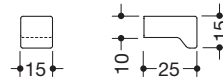

HEWI Cupboard knob

- made of high-quality polyamide
- 15 mm wide, 15 mm high, 25 mm deep
- bolt through fixing



547.32.1

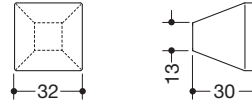

HEWI Cupboard knob

- made of high-quality polyamide
- 32 mm wide, 32 mm high, 30 mm deep
- bolt through fixing



547.32.2

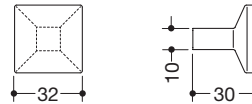

HEWI Cupboard knob

- made of high-quality polyamide
- 32 mm wide, 32 mm high, 30 mm deep
- bolt through fixing



547.32.3

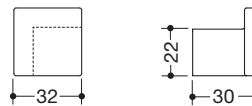

HEWI Cupboard knob

- made of high-quality polyamide
- 32 mm wide, 32 mm high, 30 mm deep
- bolt through fixing



547.32.4

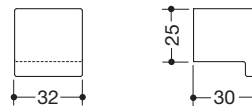

HEWI Cupboard knob

- made of high-quality polyamide
- 32 mm wide, 32 mm high, 30 mm deep
- bolt through fixing

MATERIAL | COLOUR

ORDERING INFORMATION

CROSS-REFERENCES

Polyamide

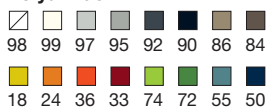

Item Number
Colour

← HEWI Fixing types **page 47**
← Cupboard knobs, matt **page 44**

Item Number

Dimensions in mm / Specification



562.10.64

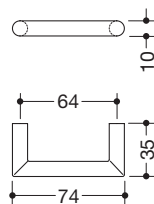

HEWI Furniture handle ø 10 mm

- made of high-quality polyamide
- centre to centre 64 mm, 35 mm deep
- bolt through fixing



562.10.96

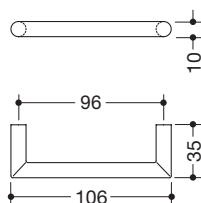

HEWI Furniture handle ø 10 mm

- made of high-quality polyamide
- centre to centre 96 mm, 35 mm deep
- bolt through fixing



562.10.128

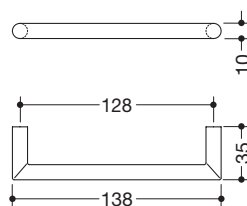

HEWI Furniture handle ø 10 mm

- made of high-quality polyamide
- centre to centre 128 mm, 35 mm deep
- bolt through fixing



562.13.96

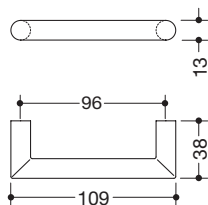

HEWI Furniture handle ø 13 mm

- made of high-quality polyamide
- centre to centre 96 mm, 38 mm deep
- bolt through fixing

MATERIAL | COLOUR

Polyamide

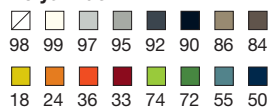

Item Number

Dimensions in mm / Specification



562.13.128

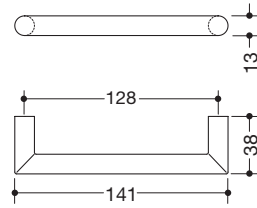

HEWI Furniture handle ø 13 mm

- made of high-quality polyamide
- centre to centre 128 mm, 38 mm deep
- bolt through fixing



562.13.192

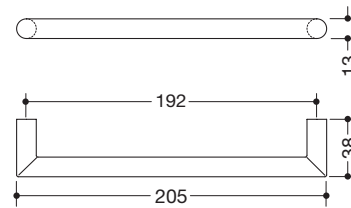

HEWI Furniture handle ø 13 mm

- made of high-quality polyamide
- centre to centre 192 mm, 38 mm deep
- bolt through fixing



544.54.120

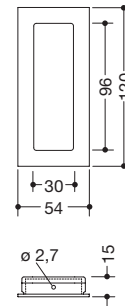

HEWI Flush pull

- made of high-quality polyamide
- recessed dimensions 114,5 x 48,5 mm, recessed depth 13 mm



544.60

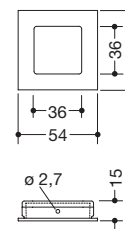

HEWI Flush pull

- made of high-quality polyamide
- recessed dimensions 54,5 x 54,5 mm, recessed depth 13 mm

ORDERING INFORMATION

CROSS-REFERENCES

Item Number
Colour

- ← HEWI Fixing types **page 47**
- ← Furniture handles, matt **from page 42**
- ← Flush pulls, matt **page 49**

Range 270

Architecture in miniature



Model 270XAM

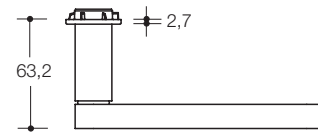
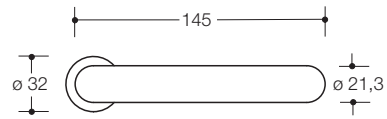

Lever handle 270XAM with mini roses
Stainless steel satin
 EN 1906 class 4

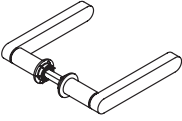
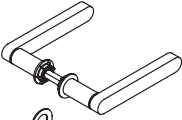
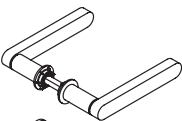
Model 270XAM	mini roses stainless steel
Standard door fitting without escutcheon class 4	 270XAM06.130
Standard door fitting class 4	 270XAM01.130
Vacant/engaged fitting class 4	 270XAM02.130

Escutcheon (self-adhesive)
 for standard door fittings
306XAM Stainless steel



Rose with turn knob | M, FBM (coin)
 for vacant/engaged fittings
306XAMNRHT St. steel



ORDERING INFORMATION

CROSS-REFERENCES

Item Number
Square
Door thickness
Keyway

HEWI Spindles, installation jigs
 see Catalogue Hardware 2018/19 page 199

Panic bar glow Guide in the dark



Item Number

Dimensions in mm / Specification



PS160XA11

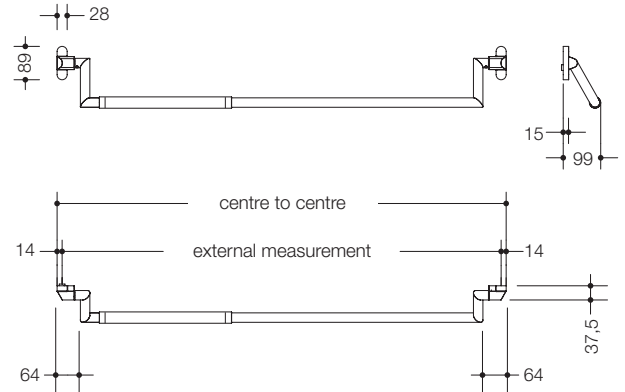

HEWI Panic bar to EN 1125

- made of stainless steel, satin finish surface
- handle made of stainless steel tube \varnothing 25 mm
- with tubular handle made of high-quality polyamide \varnothing 30 mm
- 20 mm wide luminescent rings on the two outer sides for orientation in case of light failure
- two gear units with stainless steel cover cap
- push-bar extendable to the required mounting distance

Please indicate the mounting distance, see page 65

Spindle please order separately, see page 65

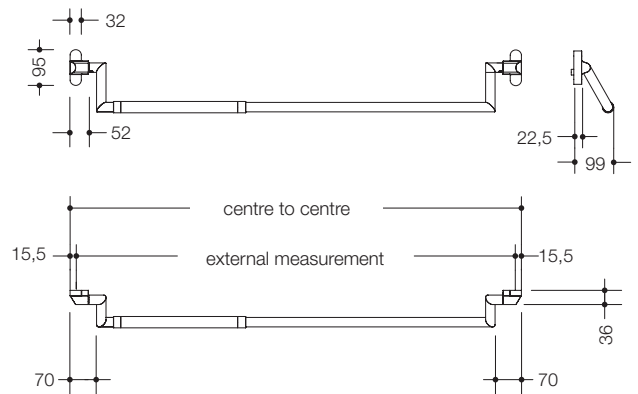

PS160XA31

HEWI Panic bar to EN 1125

- do., certified by lock manufacturers **BKS**
- with metal coated polyamide cap

Please indicate the mounting distance, see page 65

Spindle please order separately, see page 65

MATERIAL | SURFACE | COLOUR

Polyamide (tubular handle)



Stainless steel (base material)
satin

ORDERING INFORMATION

Item Number

Material/colour handle tube

Lock manufacturers: Assa Abloy, BKS, BMH, Fuhr, GEZE, Grundmann, KFV, MSL, DOM or Wilka

Inactive leaf or active leaf

If applicable pivot of lock, mounting distance, opening direction of door (DIN), door thickness

FURTHER INFORMATION

→ see pages 64-65



PS111XA11

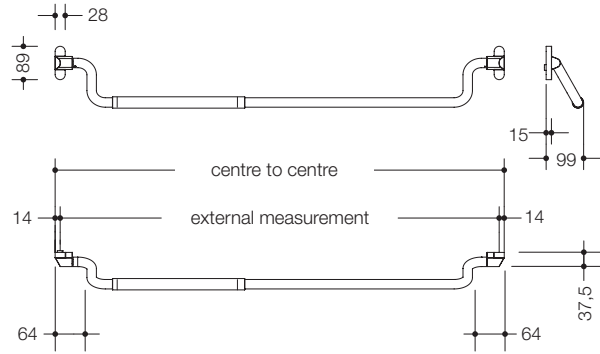

HEWI Panic bar to EN 1125

- made of stainless steel, satin finish surface
- handle made of stainless steel tube \varnothing 25 mm
- with tubular handle made of high-quality polyamide \varnothing 30 mm
- 20 mm wide luminescent rings on the two outer sides for orientation in case of light failure
- two gear units with stainless steel cover cap
- push-bar extendable to the required mounting distance

Please indicate the mounting distance, see right

Spindle please order separately, see right

PS111XA31

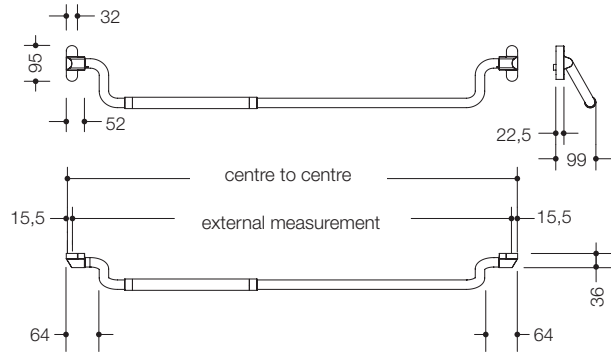

HEWI Panic bar to EN 1125

- do., certified by lock manufacturers **BKS**
- with metal coated polyamide cap

Please indicate the mounting distance, see right

Spindle please order separately, see right

MATERIAL | SURFACE | COLOUR

Polyamide (tubular handle)

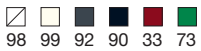

Stainless steel (base material)
satin

EMERGENCY | FRAMED DOOR FITTINGS



Changes in length beyond a mounting distance of 1250 mm (door width 1300 mm) depend on the current certification protocol of the lock manufacturer.

From EN 1125 : 2008, larger door leaf widths, heights and weights are allowed.

Item Number

Dimensions in mm / Specification

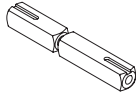
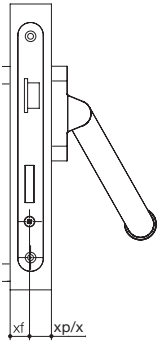

72.3PS

HEWI Spindle for panic bar for anti-panic lock w. split follower
 · made of zinc-coated steel

Ordering Information

- Item Number
- Square 9 mm **F**
- Measurement xf/xp

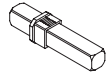

72.9PS

HEWI Spindle for panic bar to plug in mounting
 · made of zinc-coated steel

Ordering Information

- Item Number
- Square 9 mm **F**
- Measurement x

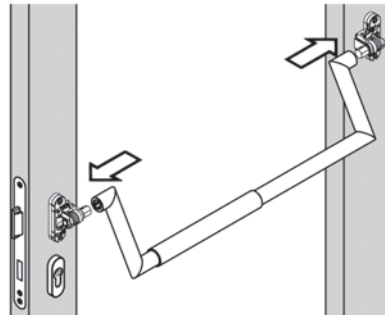

The panic bars are telescopic (extendable) within the fixings centre-to-centre ranges:

436 - 485 mm	761 - 860 mm
486 - 535 mm	861 - 1010 mm
536 - 585 mm	1011 - 1160 mm
586 - 635 mm	1161 - 1300 mm
636 - 685 mm	1301 - 1440 mm
686 - 760 mm	1441 - 1580 mm

To apply duty of **EN 1125**, availability of HEWI Panic bar or other questions on the subject we advise you if necessary by telephone or in direct personal contact.

Hotline
 +49 5691 82-300 or international@hewi.com

ORDERING INFORMATION

Item Number

Material/colour handle tube

Lock manufacturers: Assa Abloy, BKS, BMH, Fuhr, GEZE, Grundmann, KFV, MSL, DOM or Wilka

Inactive leaf or active leaf

If applicable pivot of lock, mounting distance, opening direction of door (DIN), door thickness

ADDITIONAL PRODUCTS

711BD... Symbol Push, matt **page 50**

711BZ... Symbol Pull, matt **page 50**

711D... Symbol Push, polished

711Z... Symbol Pull, polished

Kids | *Drop it*

Child-friendly equipment





Item Number

Dimensions in mm / Specification

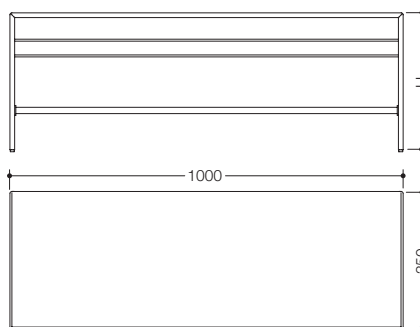

M20.05.001
M20.05.002
M20.05.003

HEWI Bench with shoe rack

- made of birch multiplex, material thickness 12 mm
- body joined by mitre
- safety edges with 5 mm radius, waxed milled edges
- surface on both sides with thermoplastic coating (polypropylene), decor white, with slight texture
- shoe rack made of steel tube with abrasion resistant powder coating in anthracite, matt
- seat depth 350 mm, length 1000 mm
- mobile version: benches are placed next to each other without connection
- seat height H 260 mm
- seat height H 350 mm
- seat height H 430 mm



M20.01.001

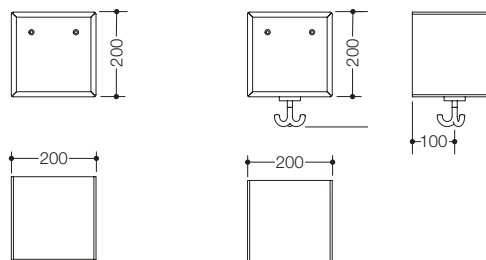

HEWI Single cube

- shelving cube for individual design of cloakrooms in crèche/nursery/school
- made of birch multiplex, material thickness 12 mm
- body joined by mitre
- safety edges with 5 mm radius, waxed milled edges
- surface on both sides with thermoplastic coating (polypropylene), decor white, with slight texture
- 200 mm wide, 200 mm high, 200 mm deep
- inside compartment dimensions: 176 mm wide, 176 mm high, 188 mm deep
- concealed wall fixing
- supplied with fixing material

Colour sample



M20.01.002

HEWI Single cube with triple hook

- do., with triple hook (rotatable) made of high-quality polyamide
- Please advise colour of hook when ordering.

MATERIAL | COLOUR

Polyamide

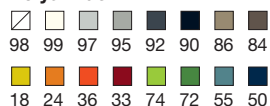

Item Number

Dimensions in mm / Specification



Colour sample

M20.02.001

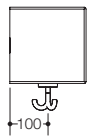
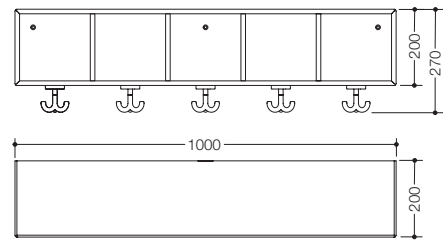
**HEWI Row module, 5 places with triple hook**

- hanging shelf for cloakroom areas in nursery or school with triple hooks
- made of birch multiplex, material thickness 12 mm
- body joined by mitre, 5 compartments
- safety edges with 5 mm radius, waxed milled edges
- surface on both sides with thermoplastic coating (polypropylene), decor white, with slight texture
- 1000 mm wide, 200 mm high, 200 mm deep (without hooks)
- inside compartment dimensions: 186 mm wide, 176 mm high, 188 mm deep
- with 5 triple hooks (rotatable) made of high-quality polyamide
- colours of triple hooks individually selectable
- distance between triple hooks is 200 mm
- concealed wall fixing, supplied with fixing material
- extension of places with further modules M20.02.001
- for individualisation, additional HEWI pictogram sheets in blank version available for labelling 33.1772E or with motifs 33.1772A, 33.1772B or 33.1772D

Please advise colour of hooks when ordering.



Colour sample

M20.02.002

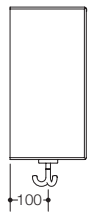
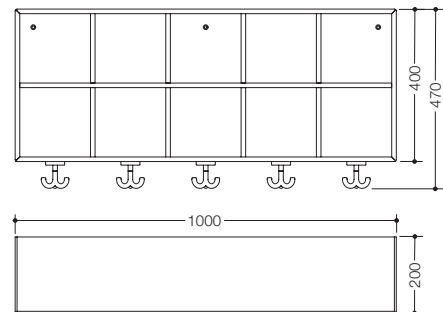
**HEWI Double module, 5 places with triple hook**

- do, 5 places, 2 compartments per child arranged on top of each other
- body joined by mitre, 10 compartments in total
- safety edges with 5 mm radius, waxed milled edges
- 1000 mm wide, 400 mm high, 200 mm deep (without hooks)
- inside compartment dimensions: 186 mm wide, 182 mm high, 188 mm deep
- colours of triple hooks individually selectable
- extension of places with further modules M20.02.002

Please advise colour of hooks when ordering.

ORDERING INFORMATION

Item Number
Colour

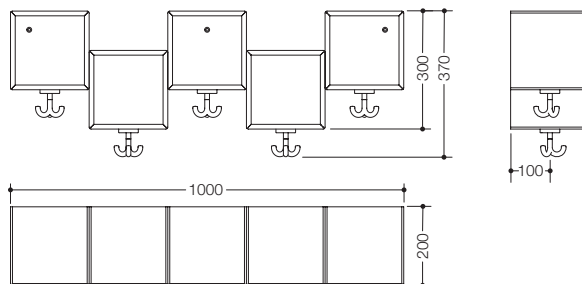
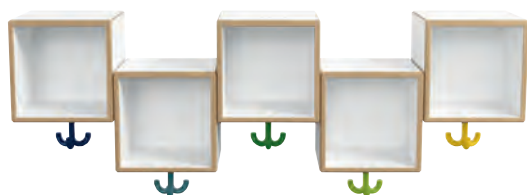

M20.03.001

Colour sample

HEWI Asymmetric row module, 5 places with triple hook

- hanging shelf for cloakroom areas in nursery or school with triple hooks
- 5 single compartments joined by mitre, connected asymmetrically
- made of birch multiplex, material thickness 12 mm
- safety edges with 5 mm radius, waxed milled edges
- surface on both sides with thermoplastic coating (polypropylene), decor white, with slight texture
- 1000 mm wide, 300 mm high, 200 mm deep (without hooks)
- inside compartment dimensions: 176 mm wide, 176 mm high, 188 mm deep
- with 5 triple hooks (rotatable) made of high-quality polyamide
- colours of triple hooks individually selectable
- distance between triple hooks is 200 mm
- concealed wall fixing
- supplied with fixing material
- extension of the places with extension module M20.03.002
- for individualisation, additional HEWI pictogram sheets in blank version available for labelling 33.1772E or with motifs 33.1772A, 33.1772B or 33.1772D

Please note

For a continuous asymmetrical mounting, alternately order row module M20.03.001 and extension module M20.03.002.

Please advise colour of hooks when ordering.

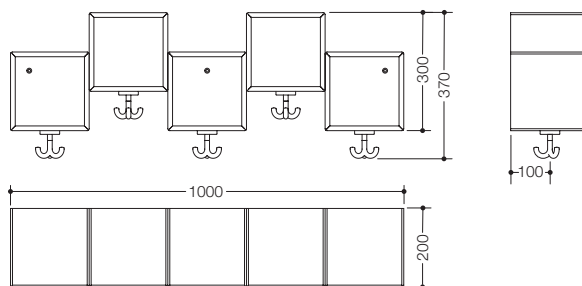

M20.03.002

HEWI Asymmetric row module extension, 5 places with triple hooks

- do., module extension for M20.03.001, for extension of places

Please advise colour of hooks when ordering.

MATERIAL | COLOUR

Polyamide

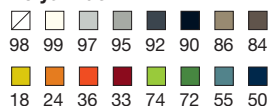

Item Number

Dimensions in mm / Specification

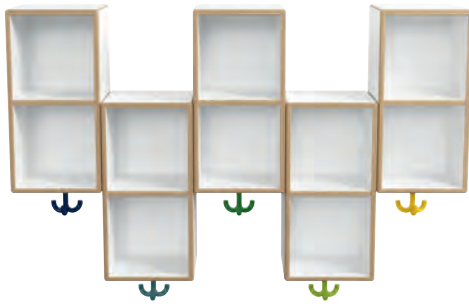

Colour sample

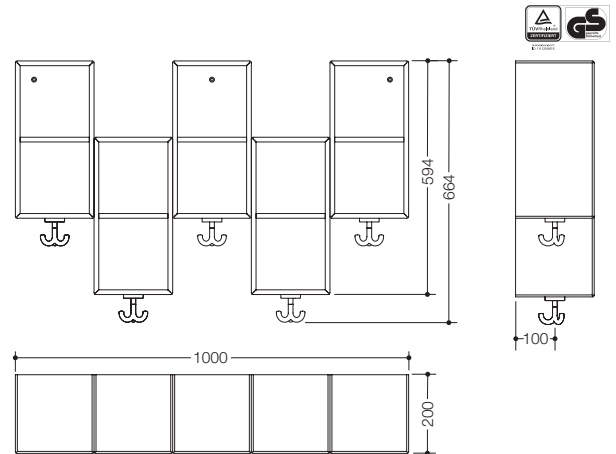
M20.03.003**HEWI Asymmetric double module, 5 places with triple hook**

- hanging shelf for cloakroom areas in nursery or school with triple hooks
- 5 double compartments, connected asymmetrically
- made of birch multiplex, material thickness 12 mm
- body joined by mitre, 10 compartments in total
- safety edges with 5 mm radius, waxed milled edges
- surface on both sides with thermoplastic coating (polypropylene), decor white, with slight texture
- 1000 mm wide, 600 mm high, 200 mm deep (without hooks)
- inside compartment dimensions: 176 mm wide, 182 mm high, 188 mm deep
- with 5 triple hooks (rotatable) made of high-quality polyamide
- colours of triple hooks individually selectable
- distance between triple hooks is 200 mm
- concealed wall fixing, supplied with fixing material
- extension of the places with extension module M20.03.004
- for individualisation, additional HEWI pictogram sheets in blank version available for labelling 33.1772E or with motifs 33.1772A, 33.1772B or 33.1772D

Please advise colour of hooks when ordering.

Please note

For a continuous asymmetrical mounting, alternately order double module M20.03.003 and extension module M20.03.004.

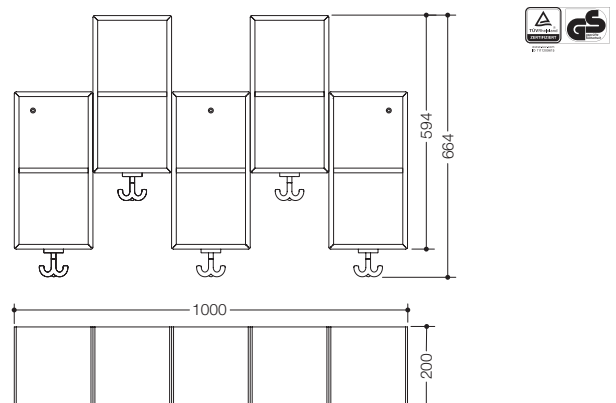
**M20.03.004****HEWI Asym. double module extension, 5 places with triple hooks**

- do., module extension for M20.03.003, for extension of places

Please advise colour of hooks when ordering.

ORDERING INFORMATION

Item Number
Colour

HEWI

www.hewi.com

GERMANY

HEWI Heinrich Wilke GmbH

Postfach 1260

34442 Bad Arolsen

Phone: +49 5691 82-0

Fax: +49 5691 82-319

international@hewi.com